

# SPECIFICATION FOR APPROVAL

## 承認書

Description : Micro Dynamic Speaker

Singatron Part No. : SES1308C-03

Customer's Model No. :

Specification No. : DRO-7499

Number Of The Edition : 1.2

### CUSTOMER'S APPROVED SIGNATURE

--	--	--

### SINGATRON ENT. CO., LTD.

13925 Magnolia Avenue

Chino, California 91710

United States of America

Tel: (909) 464-1883

Fax: (909) 464-1884

Website: [www.singatron.com](http://www.singatron.com)

Approved by	Checked by	Issued by

## A. SCOPE 範疇

This specification applies speaker, **SES1308C-03**

此規格書適用於喇叭，**SES1308C-03**

## B. SPECIFICATION 規格

No.	Item	Symbol	Unit	Specification	Condition
1	Dimension 尺寸		mm	$\varphi$ 13.0 x 3.1	
2	Power Rating 功率		W	Rated. 0.3/ MAX. 0.5	Maximum Power:IEC-60268-5 Filter 60s On/120s Off 10 Cycles (Room TEMP.)
3	Impedance 阻抗	$\Omega$	ohm	$8 \pm 15\%$	At 2KHz 1.0V
4	Resonance Frequency 低音諧振	Fo	Hz	$1100 \pm 20\%$	At ,1.0V
5	Output S.P.L. 音壓位準		dB	$84 \pm 3\text{dB}(0.3\text{w}/10\text{cm})$ $70 \pm 3\text{dB}(1\text{w}/1\text{m})$	At 1.5k,2.0k,2.5k,3.0KHz (Average figures)
6	Frequency Rang 有效頻寬		Hz	Fo---20K	
7	Distortion 失真		%	10% Max.	At 1KHz , 0.3W
8	Voice Coil 音圈		mm	-----	
9	Magnet 磁石		mm	$\varphi$ 6.5 x 0.8	Nd-Fe-B (鈦鐵錳)
10	Flux Density 磁通密度		Gauss	2200	
11	Operating temp. 操作溫度		°C	- 20 ~ +55	
12	Buzze & Rattle 異常音				Not be audible at 1.55V sine wave between Fo ~ 20KHz 輸入 1.55V 正弦波從 Fo 到 20KHz 之間無異常音
13	Weight 重量		g	1.1	
14	Material 材質			Metal	
15	Environmental Protection Regulation 環保法規			RoHS 2.0	

### C. TYPICAL FREQUENCY RESPONSE CURVE 頻率響應曲線

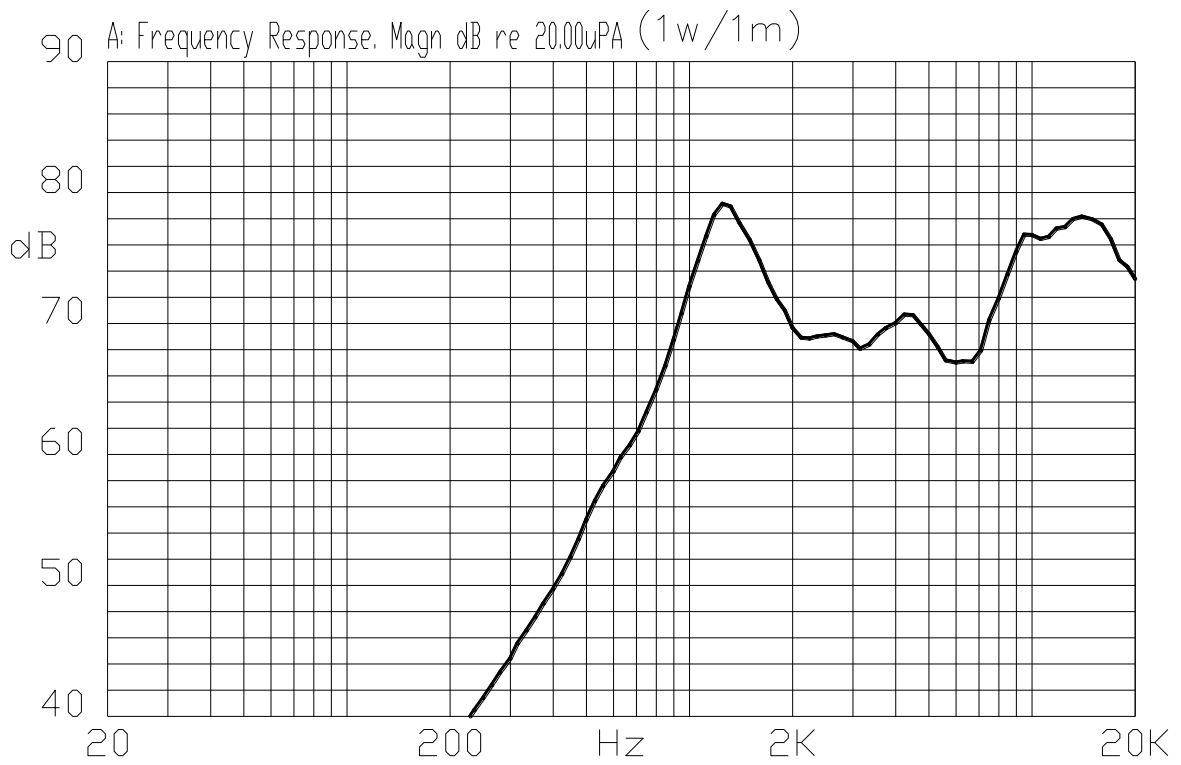
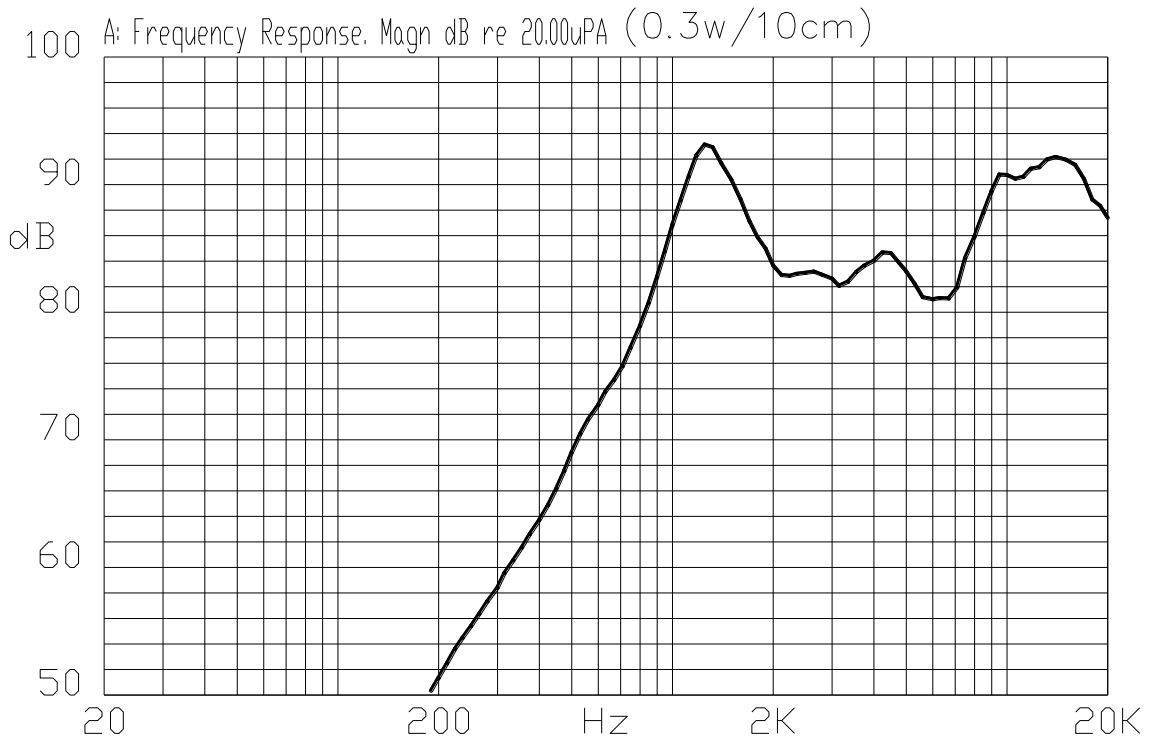

### D. APPEARANCE DRAWING 外觀尺寸圖

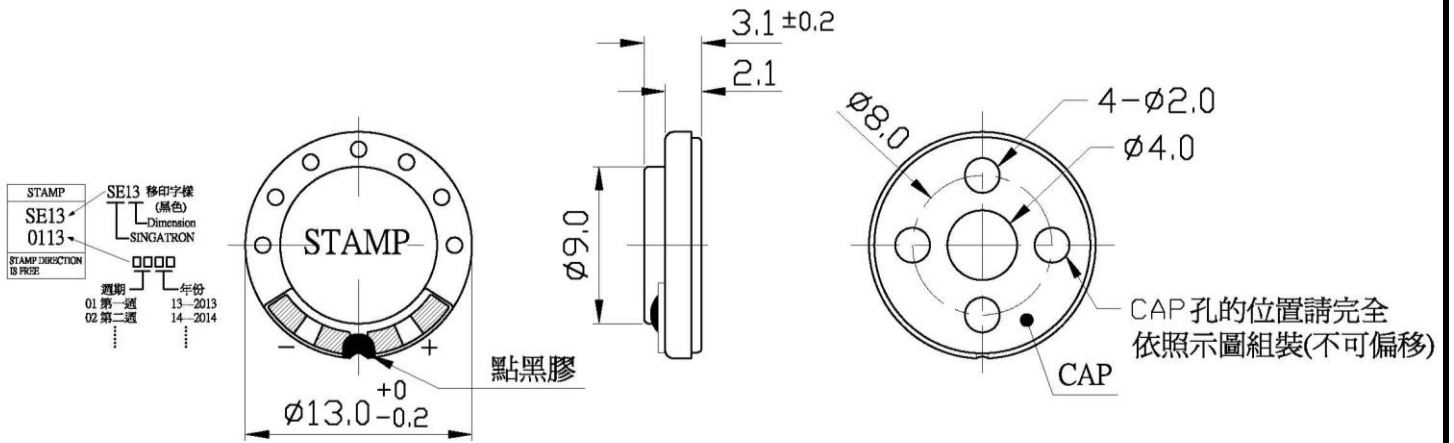

Tol:  $\pm 0.2$

Unit: mm

### E. MEASUREMENT CIRCUIT 測量線路

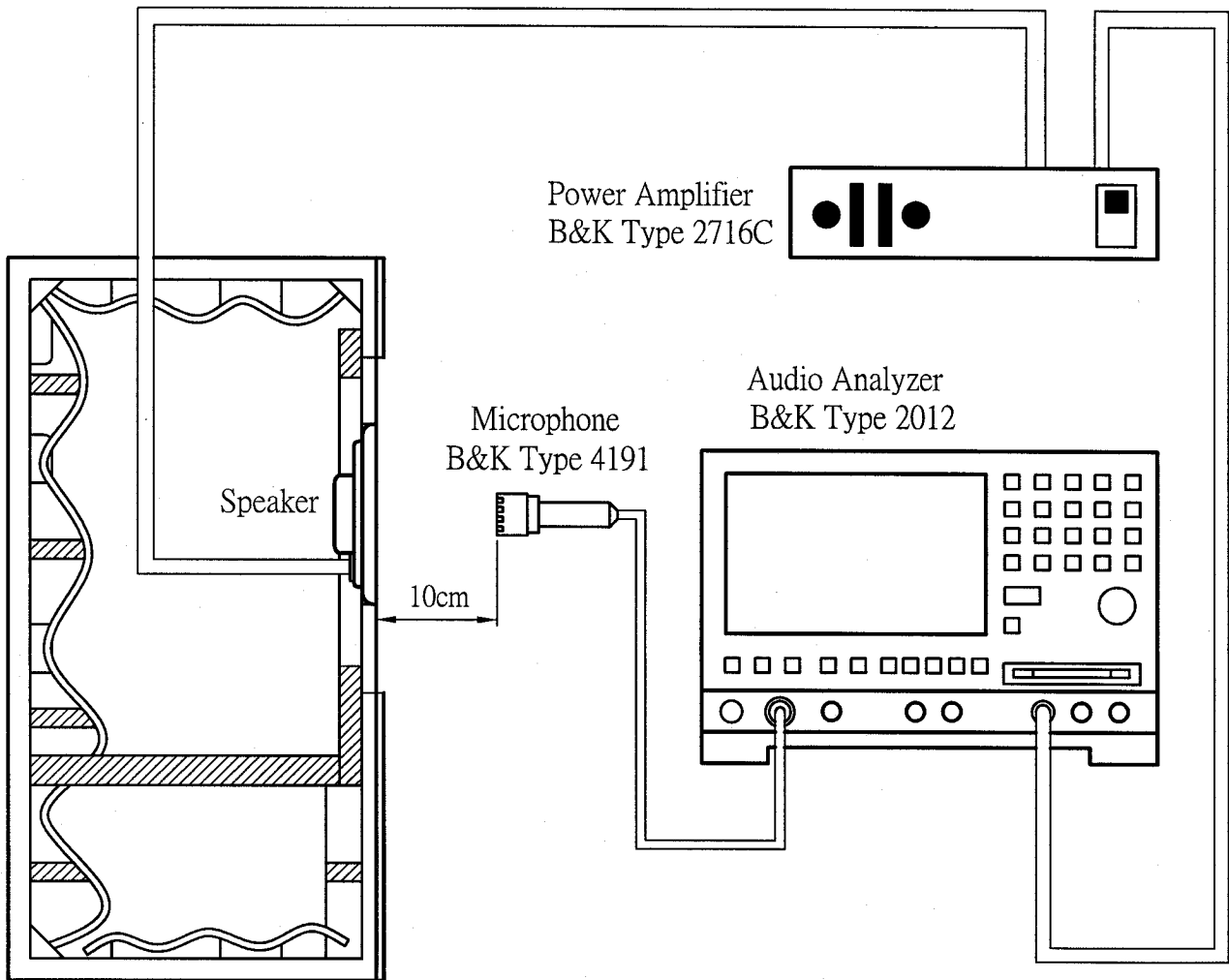

JIS C5531

940mm x 640mm x 1240mm

## F. MECHANICAL CHARACTERISTICS 機械特性

No.	Item	Test condition	Evaluation standard
1	PCB Wire Pull Strength PCB 線材拉力	The pull force shall be applied to double lead wire : Horizontal 3.0N(0.306kg) for 30 seconds. 雙線材水平方向施以 3.0N(0.306kg)的力量,30 秒.	No damage and cutting off. 不鬆動,不脫落.
2	Vibration Test 振動測試	Speaker shall be measured after being applied vibration of amplitude of 1.5mm with 10 to 55Hz band of vibration frequency to each of 3 per-pendicular directions for 2 hours. 振動週波數 10~55Hz、全振幅 1.5mm 於 X.Y.Z 3 個方向,各 2 小時.	No obstacle to be harmful to normal operation; damages, cracks, rusts and distortions. Should not be audible at 1.55V sine wave between Fo ~ 20KHz
3	Drop Test 落下測試	Drop the speakers contained in normal box onto the board 40mm thick 10 times from the height of 75cm 將揚聲器置於盒中,自 75 公分高度落在 40mm 木板上共 10 次	測試後無任何障礙防礙正常操作.且在輸入 1.55V 正弦波從 Fo 到 20KHz 之間無異常音

## G. ENVIRONMENTAL TEST 環境試驗

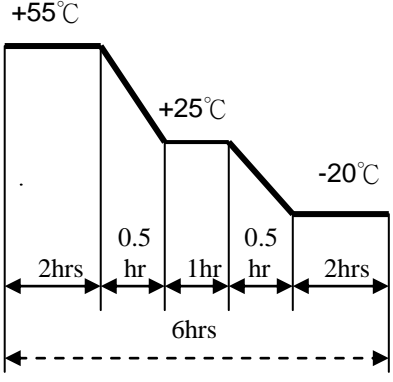
No.	Item	Test conditions	Evaluation standard
1	High temp. Test 高溫測試	After being placed in a chamber at +55°C for 96 hours 置於+55°C環境中 96 小時	Being placed for 6 hours at +25°C, speaker shall be measured. No obstacle to be harmful to normal operation; damages, cracks, rusts, etc. Should not be audible at 1.55V sine wave between Fo ~ 20KHz. Fo should meet initial one. S.P.L. deviation of unit should be within ±3dB 經測試後,靜置於+25°C (室溫)環境中 6 小時後,測試後無任何障礙防礙正常操作.且在輸入 1.55V 正弦波從 Fo 到 20KHz 之間無異常音. Fo 與原規格值相同輸出音壓變化量在±3dB 內
2	Low temp. Test 低溫測試	After being placed in a chamber at -20°C for 96 hours. 置於-20°C環境中 96 小時	
3	Humidity test 相對濕度測試	After being placed in a chamber at +40°C and 90±5% RH relative humidity for 96 hours. 置於+40°C, 相對濕度 90±5%環境中 96 小時	
4	Temp. cycle test 溫度循環測試	The part shall be subjected to 5 cycles. One cycle shall be consist of: 單體承受溫度循環測試 5 次,其循環內容如圖示: 	

## H. Recommended Temperature Profile For Hand Soldering 建議手焊溫度

Hand Soldering
370±10°C / 3±1 Sec



# I. RELIABILITY TEST 信賴性試驗

No.	Item	Test conditions	Evaluation standard
1	Load test 連續負荷	0.3W white noise is applied for 24 hours, at room temp. 在室溫下,輸入功率 0.3W, 白雜音連續操作 24 小時.	Being placed for 1 hours at +25°C, speaker shall be measured.No obstacle to be harmful to normal operation; damages, cracks, rusts, etc. Should not be audible at 1.55V sine wave between Fo ~ 20KHz. Fo should meet initial one. S.P.L. deviation of unit should be within ±3dB 經測試後,靜置於+25°C(室溫)環境中 1 小時後,測試後無任何障礙防礙正常操作.且在輸入 1.55V 正弦波從 Fo 到 20KHz 之間無異常音.Fo 與原規格值相同輸出音壓變化量在±3dB 內

## TEST CONDITION.

Standard Test Condition :	a) Temperature : +5 ~ +35°C	b) Humidity : 45-85%	c) Pressure : 860-1060mbar
一般測試條件 :	a) 溫度 : +5 ~ +35°C	b) 濕度 : 45-85%	c) 氣壓 : 860-1060mbar
Judgement Test Condition	a) Temperature : +25 ± 2°C	b) Humidity : 60-70%	c) Pressure : 860-1060mbar
爭議時測試條件:	a) 溫度 : +25 ± 2°C	b) 濕度 : 60-70%	c) 氣壓 : 860-1060mbar

# J. PACKING STANDARD 包裝規格

	 <table border="1" style="margin: auto;"> <tr><td>Type</td><td></td></tr> <tr><td>Specification</td><td></td></tr> <tr><td>Quantity</td><td></td></tr> <tr><td>Number</td><td></td></tr> <tr><td>Weight</td><td></td></tr> </table>	Type		Specification		Quantity		Number		Weight			 <table border="1" style="margin: auto;"> <tr><td>Type</td><td></td></tr> <tr><td>Specification</td><td></td></tr> <tr><td>Quantity</td><td></td></tr> <tr><td>Number</td><td></td></tr> <tr><td>Weight</td><td></td></tr> </table>	Type		Specification		Quantity		Number		Weight	
Type																							
Specification																							
Quantity																							
Number																							
Weight																							
Type																							
Specification																							
Quantity																							
Number																							
Weight																							

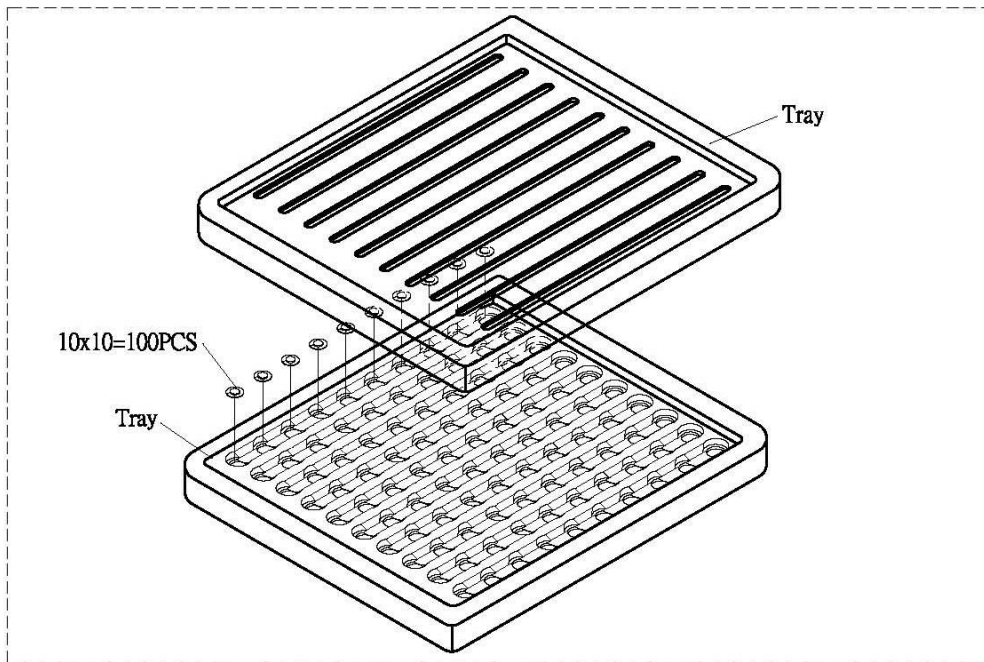

Lot No.	XXXXXXXXXX
Model No.	XXXXXXXXXX
Quantity.	XXXX Pcs
Date:	DD MM YY 
SINGATRON	

\* The label sticked on outer of carton

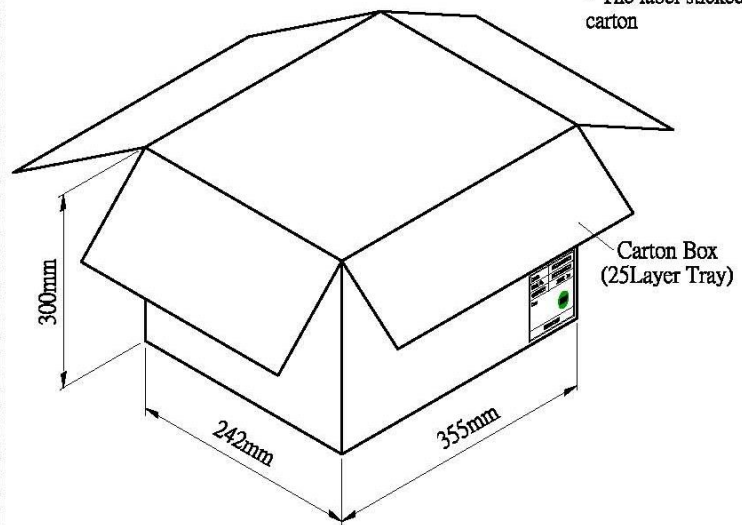
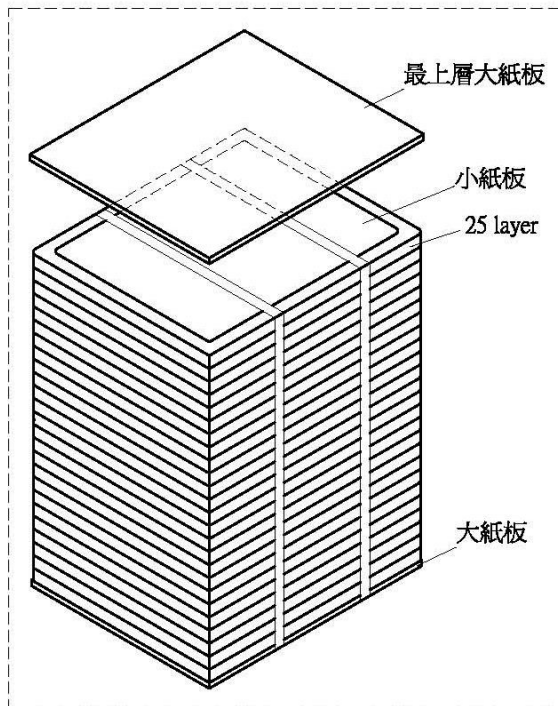

Tray	350mmx235mmx20mm	1x100PCS=100PCS
Carton Box	355mmx242mmx300mm	100PCSx25=2500PCS