

1 2 3 4 5 6 7 8

F

E

D

C

B

A

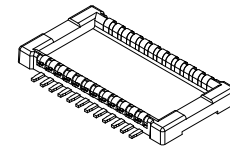
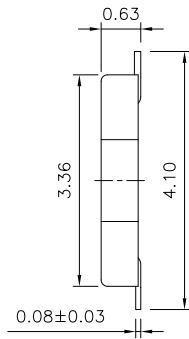
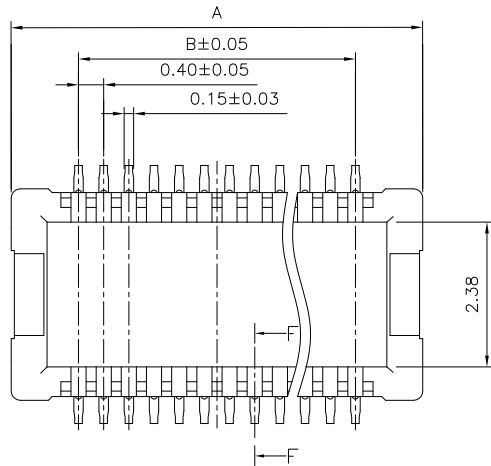

Specifications:

1. Current Rating : 0.3A AC/DC
2. Voltage Rating : 30V AC/DC
3. Contact Resistance : 80m ohm. max.
4. Insulation Resistance : 1000M ohm. min.at 250V DC
5. Withstanding Voltage :150V AC for one minute
6. Operating Temperature Range : -55°C to +85°C

Material and Plated

- 1.Housing : High Temp Plastic. (UL94V-0)
- 2.Contact : Copper Alloy
- 3.Plated : Gold Plated

How To Order

2BB2004P-XXG-H09

- Matting Height 0.90mm
- Gold Plated
- No. Of Contact
- P:Plug

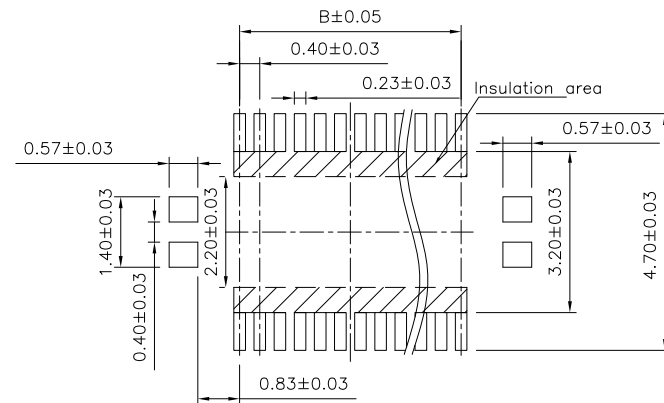
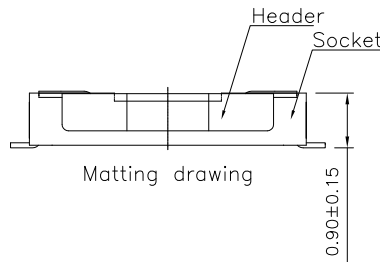
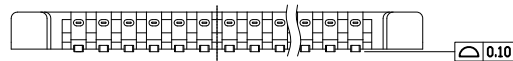

PCB Layout

RoHS Compliant

Circuits	Dim.A	Dim.B	Circuits	Dim.A	Dim.B
10	3.74	1.60	40	9.74	7.60
20	5.74	3.60	50	11.74	9.60
24	6.54	4.40	60	13.74	11.60
30	7.74	5.60	70	15.74	13.60

B			
A	19-Jul-2019		Ben Lin
REV	DATE	FILE	BY

1 2 3 4 5 6 7 8

Singatron Enterprise Co., Ltd.

TITLE	0.4mm Board To Board Plug Matting Height 0.90mm			
DWN	Ben Lin	PART NO.	2BB2004P-XXG-H09	
CHKD	Jerry Chen	SCALE	1:1	UNIT: mm
APVD	Rory Chen	SIZE	A3	SHEET: 1 / 2

GENERAL TOLERANCE:

.X = ±0.2
.XX = ±0.15

CUSTOMER COPY

1 2 3 4 5 6 7 8

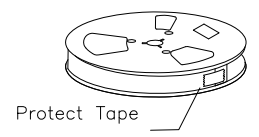
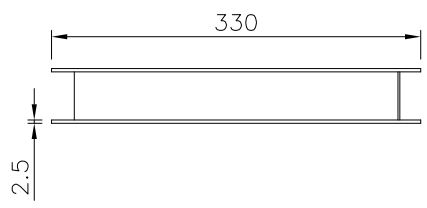

Note:
 1.All dimensions meet EIA-481-D requirements.
 2.Material: Transparent Conductive Polystyrene Alloy 100% recyclable.
 3.Thickness : 0.4±0.05mm
 4.Component load per 13" reel :5000 pcs.
 5.Carton Size:
 Carton Size:350*350*296(MM)

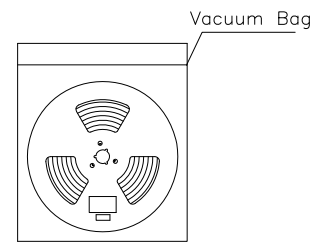
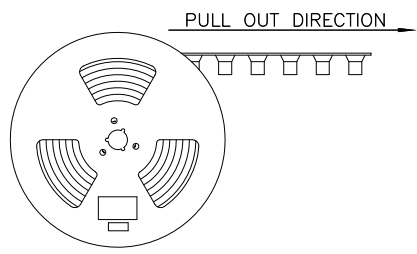

Pin No.	W	F	PCS/R	R/CTN	Q'TY
10	16	7.5	5000	12	60,000
20	16	7.5	5000	12	60,000
24	16	7.5	5000	12	60,000
30	16	7.5	5000	12	60,000
40	24	11.5	5000	9	45,000
50	24	11.5	5000	9	45,000
60	24	11.5	5000	9	45,000
70	24	11.5	5000	9	45,000

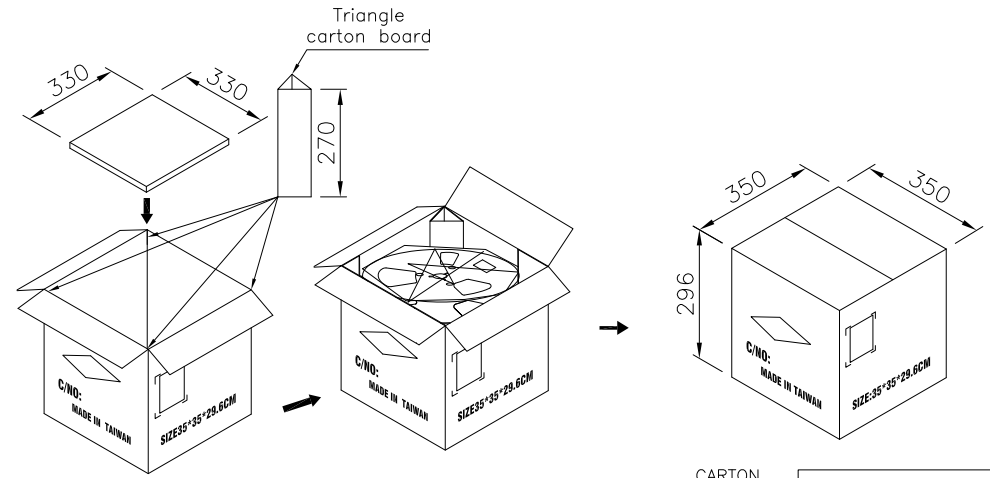
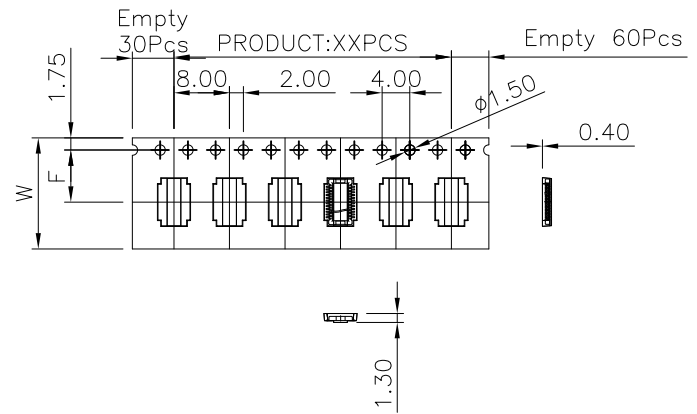

RoHS Compliant

For Reel width (dimension W)16,24mm
 Single row hole

B			
A	19-Jul-2019		Ben Lin
REV	DATE	FILE	BY

GENERAL TOLERANCE:
 .X=±0.2
 .XX=±0.15

Singatron Enterprise Co., Ltd.				
TITLE	0.4mm Board To Board Plug Matting Height 0.90mm			
DWN	Ben Lin	PART NO.	2BB2004P-XXG-H09	
CHKD	Jerry Chen	SCALE	1:1	UNIT: mm
APVD	Rory Chen	SIZE	A3	SHEET: 2 / 2
REV: A				
CUSTOMER COPY				

1 2 3 4 5 6 7 8