

REV.	ECN NO OR DESCRIPTION	REVISED	DATE
A	INITIAL RELEASE	劉木遠	2006.03.17
B	ADD DATE CODE	許海華	2007.06.14
C	ADD HALOGEN FREE MARK ECN NO:7080204	孫一中	2008.11.27

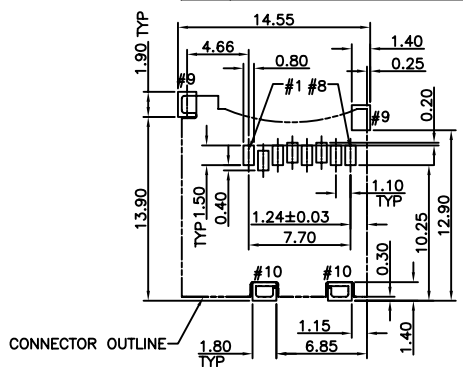

CONNECTOR OUTLINE
RECOMMENDED PCB PATTERN LAYOUT
TOLERANCE: ±0.05

- NOTES:
- MATERIAL :**
HOUSING:HIGH TEMPERATURE THERMOPLASTIC. UL94V-0.BLACK
SLIDE:HIGH TEMPERATURE THERMOPLASTIC. UL94V-0.BLACK
SHELL:STAINLESS STEEL.
CONTACT:COPPER ALLOY.
DETECT PIN: COPPER ALLOY.
LOCK PIN:STAINLESS STEEL.
 - PLATED :**
CONTACT:20u" Min. Au PLATING IN CONTACT AREA;
1~3u"Min.Au PLEATED OVERALL,
50u" Ni UNDERPLATED OVERALL.
DETECT PIN:1u" Min. Au PLATED OVER ALL.
50u"Min. Ni UNDERPLATED OVERALL .
 - ELECTRIACL CHARACTERISTIC:**
CONNECT RESISTANCE:40 MILLIONNS/PIN Max.
INSULATION RESISTANCE:1000 MEGAOHMS Min.
VOLTAGE WITHSTAND:500V AC for 1minute
 - MECHANICAL CHARACTERISTIC:**
CONTACT MATING FORCE:3Kgf Max.
CONTACT UNMATING FORCE:100gf Min.
DURABILIDADE:5000 CYCLES
 - SOLDER HEAT RESISTANCE:REFLOW SOLDERING 260° FOR 10 SEC.
 - TO CONFORM TO SINGATRON HAZARDOUS SUBSTANCE FREE SPEC.
 - HALOGEN FREE PRODUCT IDENTIFICATION MARK ON PRODUCT:
 - HALOGEN FREE PRODUCT IDENTIFICATION LOGO ON PACKING:
 - FOR REFLOW SOLDERING LEAD-FREE PROCESS.
 - PRINTED DATE CODE"YYMMDD " ON TOP OF CONNECTOR.

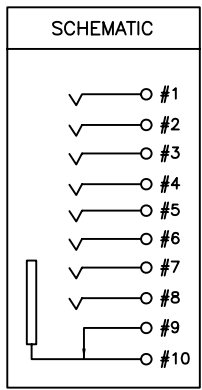
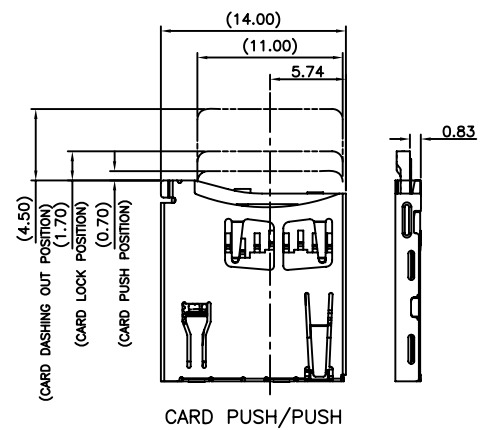
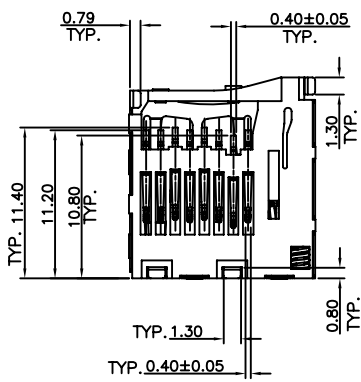
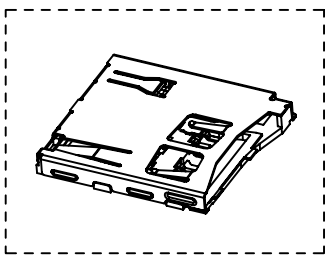
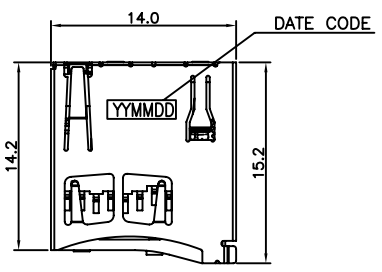
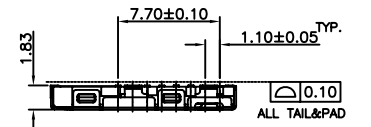

3D VIEWS

RELATION OF SWITCHES TO TRANS-FLASH
CARD ATTACHMENT CONDITION

CARD ATTACHMENT CONDITION	CARD DETECT SWITCH	SITUATION DEPICTION
CARD NOT ATTACHED	CLOSED	#9
 SHORT
CARD ATTACHED	OPEN	#9
 OPEN

Pin No.	Name	Type	DESCRIPTION
1	DAT2	I/O/PP	Data Line [bit2]
2	CD/DAT3	I/O/PP	Card Detect Data Line [bit3]
3	CMD	PP	Command Response
4	VDD	S	Supply Voltage
5	CLK	I	Clock
6	VSS	S	Supply Voltage Ground
7	DAT0	I/O/PP	Data Line [bit0]
8	DAT1	I/O/PP	Data Line [bit1]

NO	DESCRIPTION	QTY	MATERIAL	PLATING & COLOR
UNLESS OTHERWISE SPECIFIED TOLERANCES				
DECIMALS: X :±0.5 X.X :±0.3 X.XX :±0.2		ANGLES: X :±2° X.X :±1°		
TITLE		DWN 孫一中		
CHKD 劉木遠		PART NO. 2CA-0005-001		
APVD 羅文生		SCALE 2:1 UNIT: mm		
		SIZE: A3 SHEET: 10F1 REV: C		
CUSTOMER COPY				