

REV.	ECN NO.	OR DESCRIPTION	REVISED	DATE
A	PDR NO.:T151204-1A	Vicky	2015.12.07	

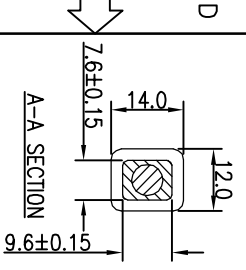

A-A SECTION

GREEN 24#	4
WHITE 24#	3
BLACK 18#	2
RED 18#	1
WIRE COLOR	CONN.

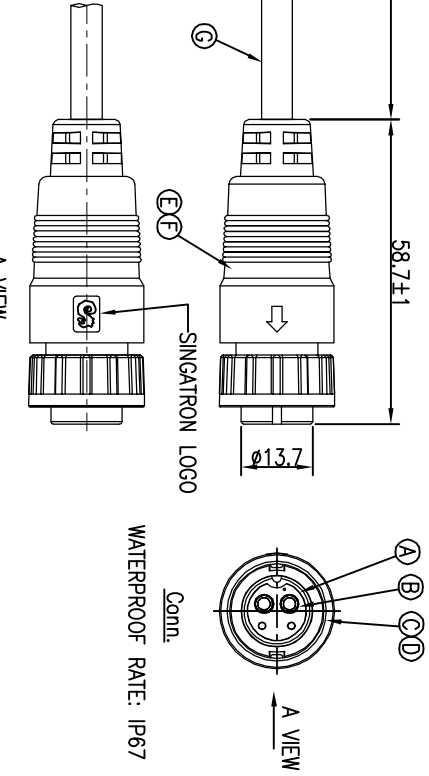
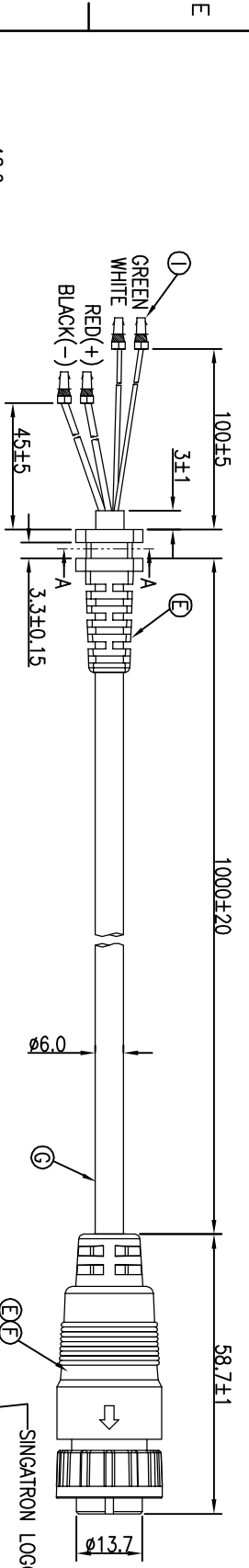
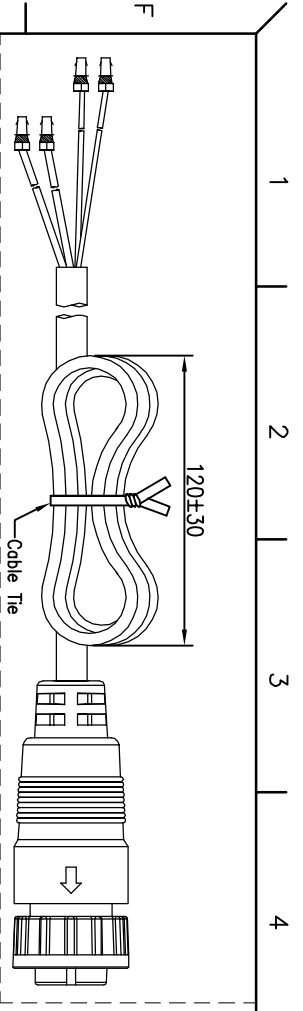
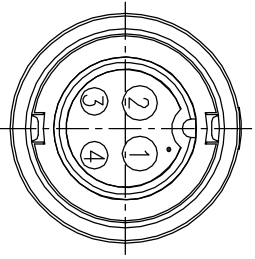
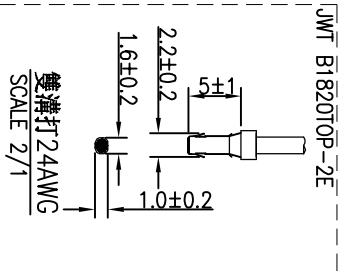
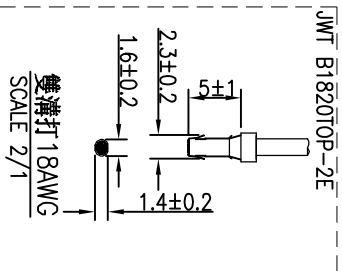

NOTES:

1. WATERPROOF RATE: IP67
2. SPECIFICATIONS: SEE "CIRCULAR SERIES SPECIFICATIONS".
3. TO CONFORM TO SINGATRON HAZARDOUS SUBSTANCE FREE SPEC.
4. GREEN PRODUCT IDENTIFICATION LABEL ON PACKAGING:

I	TERMINAL	4	PHOSPHOR BRONZE	TIN PLATING
H	MALE PIN	2	BRASS	6u" GOLD PLATING OVER NICKEL PLATING
G	CABLE	1	UL2464 18AWG+2C +(24AWG*2C+A)/MY Ø6.0	BLACK(PVC JACKET)
F	INNER MOLD	1	TPU	NATURAL
E	OVER MOLD	2	PVC	BLACK
D	O-RING	1	EPDM	BLACK
C	LOCK NUT	1	NYLON+GF	BLACK
B	MALE PIN	2	BRASS	6u" GOLD PLATING OVER NICKEL PLATING
A	BODY	1	NYLON+GF	BLACK
NO	DESCRIPTION	QTY	MATERIAL	PLATING & COLOR

UNLESS OTHERWISE SPECIFIED TOLERANCES

DECIMALS: ANGLES:

X.XX :±0.2 X.XX :±0.3 X.XX :±0.5 X.XX :±1'

Singatron Enterprise Co., Ltd.  
信譽企業股份有限公司

TITLE: CIRCULAR MIDDLE SIZE (IP67)  
FEMALE CONN. MALE PIN 4 Pin LOCK TYPE  
PART NO. 2CM3016-W04B03H  
SCALE 1:1 UNIT: mm

APVD: Steve SIZE: A2 SHEET: 1 OF 1 REV: A

CUSTOMER COPY