

- SPECIFICATIONS:**
- ELECTRICAL CHARACTERISTICS:**
 - 1-1. RATING: 20V 10A
 - 1-2. CONTACT RESISTANCE: 15mΩ MAX.
 - 1-3. DIELECTRIC WITHSTANDING VOLTAGE: 500V AC FOR ONE MINUTE.
 - 1-4. INSULATION RESISTANCE: 100MΩ MIN. MEASURED BY 500 VDC
 - MECHANICAL CHARACTERISTICS:**
 - 2-1. INSERTION FORCE: 0.8~3.5 kg (INITIAL / AFTER LIFE TEST)
 - 2-2. WITHDRAWAL FORCE: 0.5~3.5 kg (INITIAL / AFTER LIFE TEST)
 3. TEMPERATURE RISE CAN'T EXCEED 30°C
 4. LIFE TEST: 8,000 CYCLES MIN.
 5. WEIGHT: 2.55 g
 6. OTHER SPEC. REFER TO "20C-G213-B81F SPEC"
 7. TO CONFORM TO SINGARON HAZARDOUS SUBSTANCE FREE SPEC.
 8. HALOGEN FREE PRODUCT IDENTIFICATION MARK ON JACK:
 9. HALOGEN FREE PRODUCT IDENTIFICATION LABEL ON PACKAGING:
 10. FOR REFLOW SOLDERING LEAD-FREE PROCESS.
 11. PRINTED DATE CODE "YMMDD" ON TOP OF CONNECTOR.

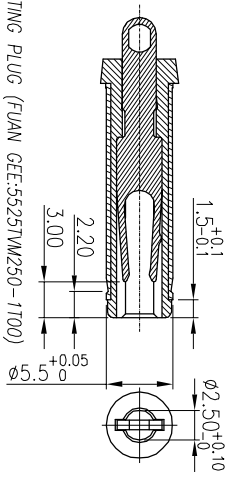

MATING PLUG (FUJAN GEE:5525TW250-1100)
TOLERANCE: X.XX:0.10

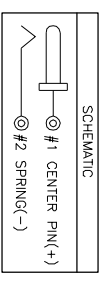
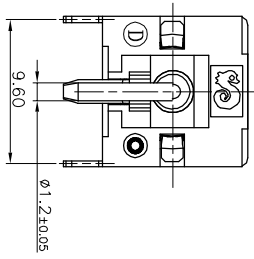
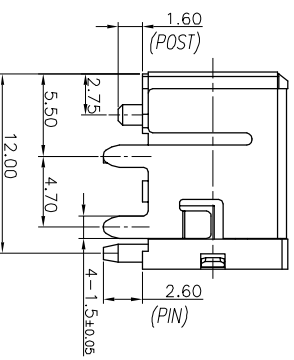
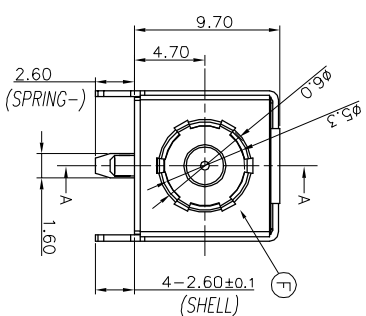
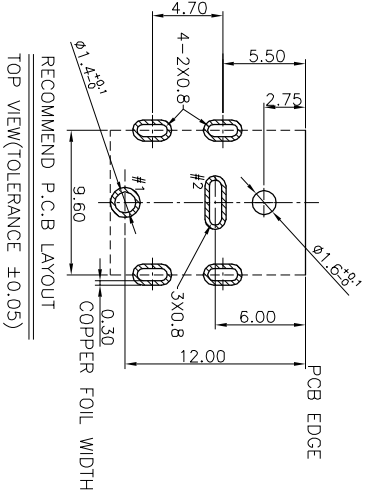
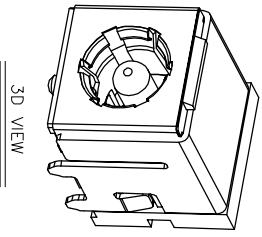
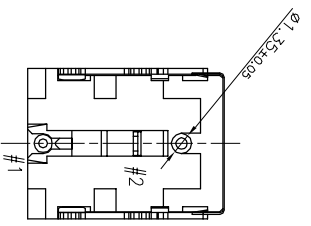

NO	DESCRIPTION	QTY	MATERIAL	PLATING & COLOR
F	GROUND	1	STAINLESS 0.15T	N/A
E	SHELL	1	STAINLESS 0.4T	Ni 60u" Min. OVER Cu 120u" Min.
D	STOPPER	1	HIGH TEMP-THERMOPLASTIC UH94V-0	NATURE
C	PIN	1	BRASS	Au 3u" Min. OVER Ni 60u" Min.
B	SPRING	1	COPPER ALLOY 0.3T	Au 3u" Min. OVER Ni 60u" Min.
A	BODY	1	HIGH TEMP-THERMOPLASTIC UH94V-0	BLACK

UNLESS OTHERWISE SPECIFIED TOLERANCES

Singatron Enterprise Co., Ltd.
信晉企業股份有限公司

φ5.5 DC POWER JACK

TITLE	DECIMALS:	ANGLES:
DWM Springwvl	:±0.5	X :±2°
CHKD Sky	:±0.3	X.X :±1°
APVD Lussen	:±0.2	X.XX :±0.2

PART NO. 2DC-G213-B81F
SCALE: 4:1
UNIT: mm
SIZE: A3
SHEET: 1 OF 2
REV: A

CUSTOMER COPY

REV.	ECN NO OR DESCRIPTION	REVISED	DATE
A	PDR NO:T160419-11A	Springwu	2018.8.10

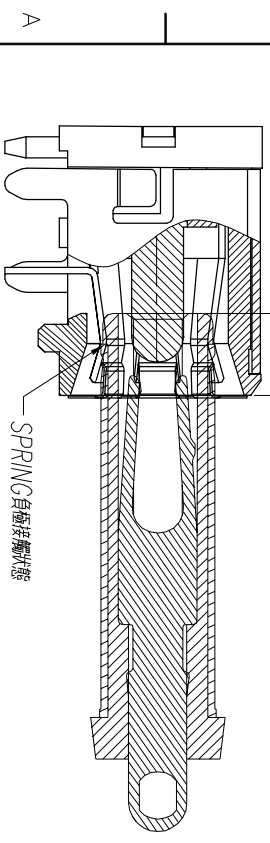
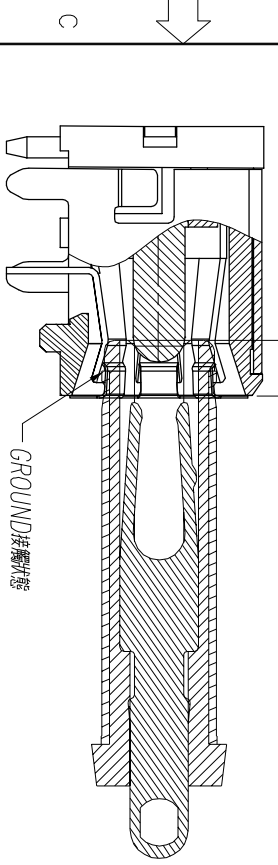
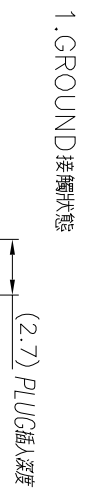
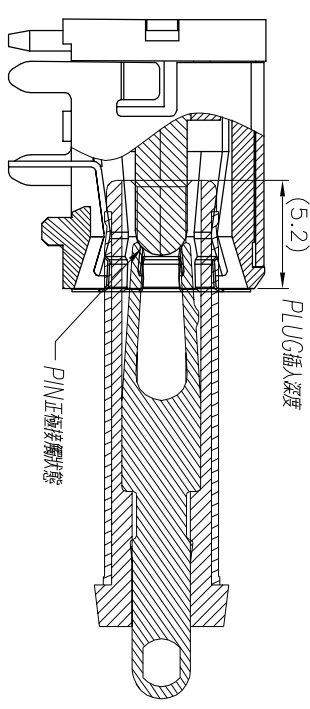
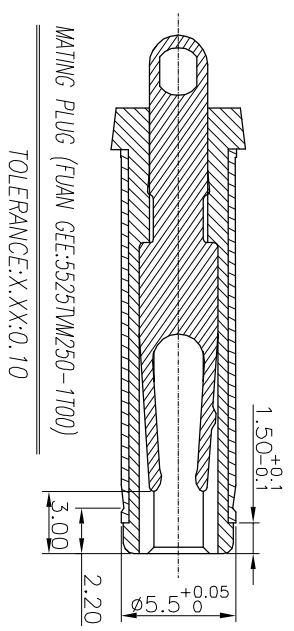
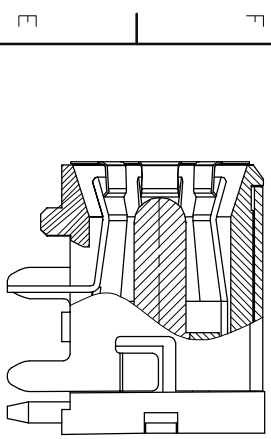

NO	DESCRIPTION	QTY	MATERIAL	PLATING & COLOR
UNLESS OTHERWISE SPECIFIED TOLERANCES				
Singatron Enterprise Co., Ltd. 信晉企業股份有限公司				
DECIMALS: ANGLES:				
X	:±0.5	X	:±2°	
X.X	:±0.3	X.X	:±1°	
X.XX	:±0.2			
TITLE: φ5.5 DC POWER JACK				
DWN	Springwu	PART NO. 2DC-G213-B81F		
CHKD	Sky	SCALE:4:1 UNIT: mm		
APVD	Lussen	SIZE: A3 SHEET:2 OF 2 REV: A		
CUSTOMER COPY				