

RoHS
Compliant

ZONE	SYMBOL	REVISION	APPROVAL	DATE

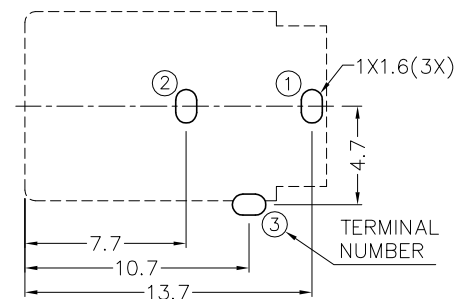

RECOMMENDED PCB LAYOUT
TOLERANCE: ±0.05
(TOP VIEW)

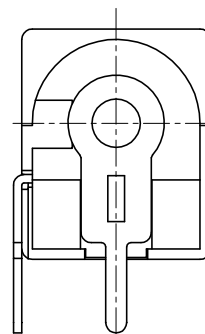
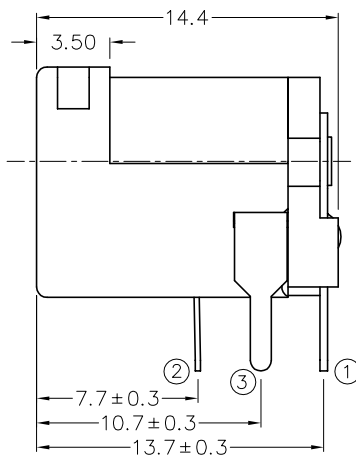
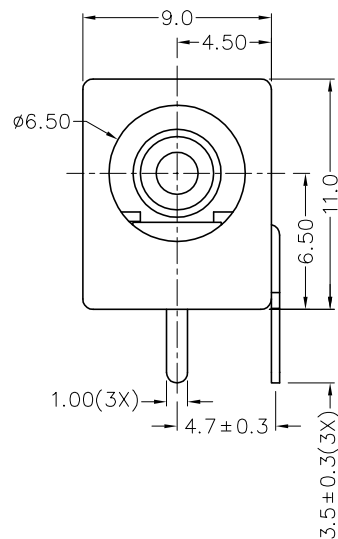
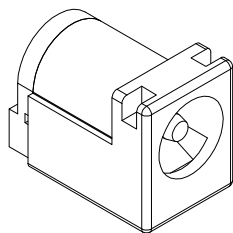
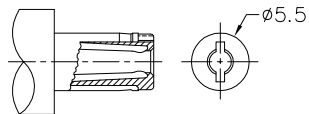

DC MATE PLUG

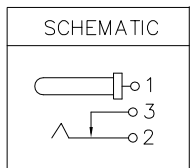

MODEL NO.	CENTER PIN
2DC-T002H-3I	ø1.65mm
2DC-T002H-3D	ø2mm
2DC-T002H-3B	ø2.5mm

* MATERIAL

CENTRE PIN : COPPER
 TERMINAL 1 : BRASS
 TERMINAL 2 : COPPER ALLOY
 TERMINAL 3 : BRASS
 HOUSING : THERMOPLASTIC
 COVER : THERMOPLASTIC

Singatron Enterprise Co., Ltd.

TITLE	HIGH CURRENT DC POWER SOCKET			
DWN	H.Q.ZHOU 12-9-2016	PART NO. 2DC-T002H-3x		
CHKD	H.L.TAN	SCALE 1:1	UNIT: mm	
APVD		SIZE: A3	SHEET: 1 OF 1	REV: 1.0

TOLERANCE UNLESS 0.0±0.2
 0.00±0.1
 OTHERWISE SPECIFIED: 0.000±0.05

CUSTOMER COPY