

RoHS
Compliant

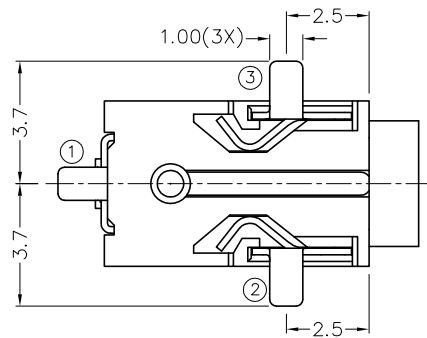

* MATERIAL

CENTRE PIN : COPPER
 TERMINAL 1 : BRASS
 TERMINAL 2 : COPPER ALLOY
 TERMINAL 3 : COPPER ALLOY
 HOUSING : HIGH TEMP. PLASTIC

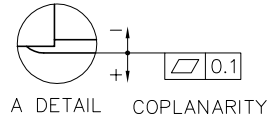
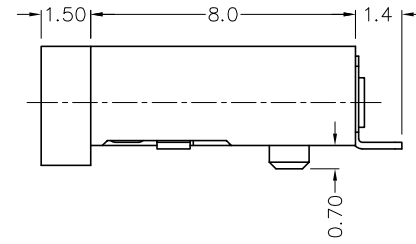
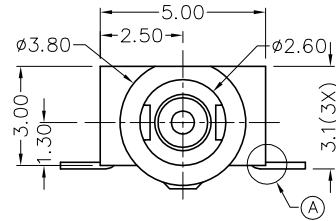
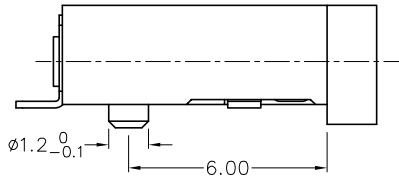
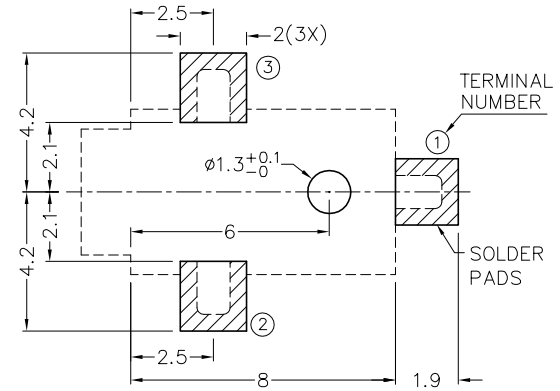

RECOMMENDED PCB LAYOUT
 TOLERANCE: ±0.05
 (TOP VIEW)

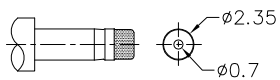

DC MATE PLUG

MODEL NO.	2DC-T064D
SCHEMATIC	
CENTER PIN	∅0.65mm

Singatron Enterprise Co., Ltd.

TITLE	SMD DC POWER SOCKET		
DWN	T.Y.LI 17-10-2016	PART NO.	2DC-T064D
CHKD	J.CHOU 17-10-2016	SCALE	1:1 UNIT: mm
APVD	H.L.TAN 17-10-2016	SIZE: A3	SHEET: 1 OF 1 REV: A

TOLERANCE UNLESS 0.0±0.2
 0.00±0.1
 OTHERWISE SPECIFIED: 0.000±0.05

CUSTOMER COPY