

DATE CODE

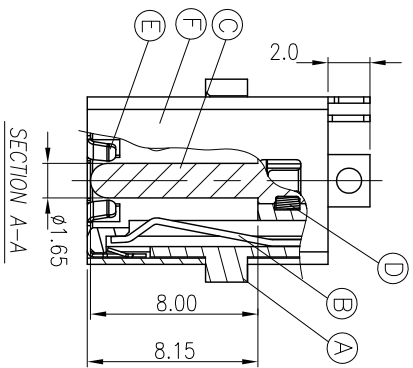

SECTION A-A

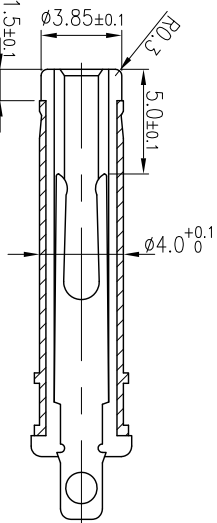
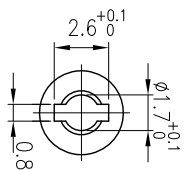
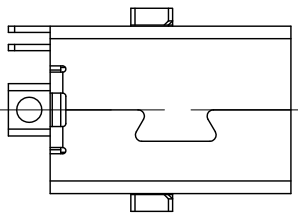
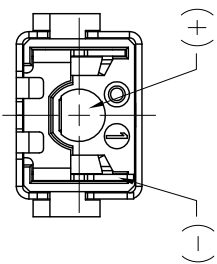
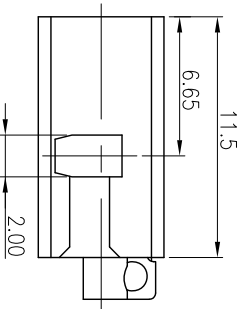
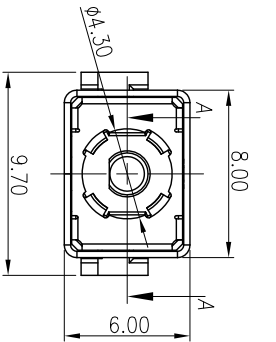
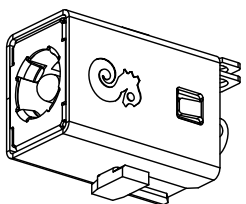

ORDER NO.
2DC1015-000111

PACKAGING
1: BAG

HOUSING COLOR
1: BLACK

CONTACT PLATING
1: GOLD-PLATED

MATING PLUG

REV.	ECN NO. OR DESCRIPTION	REVISED	DATE
A	PRODUCT RELEASE	DA	2009.04.06
B	ECN NO:S120115	SEAN	2012.02.27
C	ECN NO:S130353	SpringWang	2013.05.16

SPECIFICATIONS:

- ELECTRICAL CHARACTERISTICS:
 - RATING: 20V 3.5A
 - CONTACT RESISTANCE: 30m Ω MAX.(INITIAL)
 - DIELECTRIC WITHSTANDING VOLTAGE: 500V AC FOR ONE MINUTE.
 - INSULATION RESISTANCE: 100M Ω MIN. MEASURED BY 500 VDC
- MECHANICAL CHARACTERISTICS:
 - INSERTION FORCE : 0.5~2.0 KGF
 - WITHDRAWAL FORCE : 0.4~1.5 KGF
- LIFE TEST: 5,000 CYCLES MIN.
- OTHER GENERAL SPEC: TO REFER "2DC1015-000111 SPEC".
- TO CONFORM TO SINGATRON HAZARDOUS SUBSTANCE FREE SPEC.
- GREEN PRODUCT IDENTIFICATION MARK ON JACK:
- GREEN PRODUCT IDENTIFICATION LABEL ON PACKAGING:
- FOR HAND SOLDERING LEAD-FREE PROCESS.

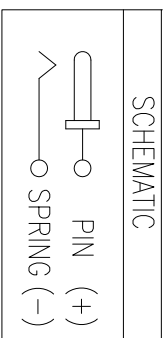

NO	DESCRIPTION	QTY	MATERIAL	PLATING & COLOR
F	SHELL	1	SPCC	5u (80u" Min.) UNDERPLATED OVER ALL & Ni (80u" Min.) PLATED OVER ALL
E	GROUND	1	STAINLESS	N/A
D	STOPPER	1	THERMOPLASTIC UL 94V-0 (HALOGEN FREE)	BLACK COLOR
C	PIN	1	COPPER ALLOY	Ni (50u" Min.) UNDERPLATED OVER ALL & GOLD-PLATED(5u" Min.) OVER ALL
B	SPRING	1	COPPER ALLOY	Ni (50u" Min.) UNDERPLATED OVER ALL, Pd/Ni (25u" Min.) & GOLD-PLATED(5u" Min.) AT CONTACT AREA.
A	HOUSING	1	THERMOPLASTIC UL 94V-0 (HALOGEN FREE)	BLACK COLOR
NO	DESCRIPTION	QTY	MATERIAL	PLATING & COLOR

UNLESS OTHERWISE SPECIFIED TOLERANCES

DECIMALS: ANGLES:

X : ±0.5 X : ±.2

X.X : ±0.3 X.X : ±.1

X:XX : ±0.2

DC POWER JACK

SpringWang PART NO. 2DC1015-000111

CHKD Gerry SCALE 4:1 UNIT: mm

APVD Max SIZE: A3 SHEET: 1 OF 1 REV: C

Singatron Enterprise Co., Ltd.
信音企業股份有限公司

CUSTOMER COPY