

REV.	ECN NO OR DESCRIPTION	REVISED	DATE
A	PDR RELEASE	EVEN	2022.03.30
B	ECN NO: L202208-C05	EVEN	2023.02.20
C	ECN NO: L202305-004	EVEN	2023.09.04

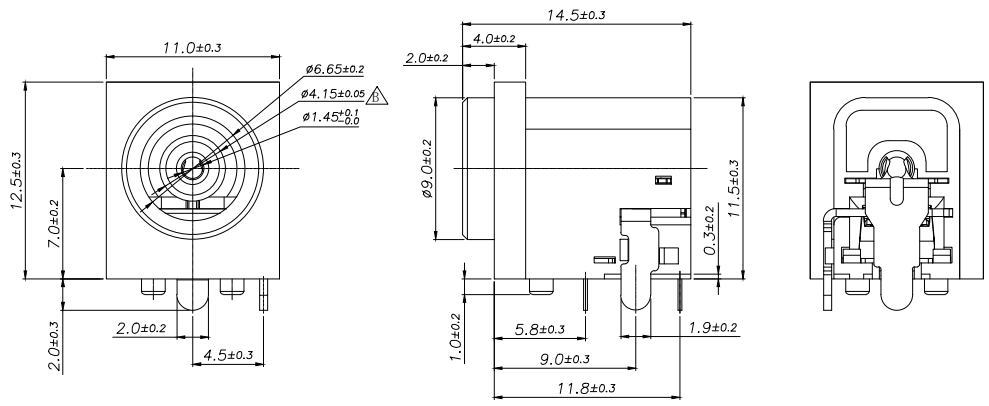

SPECIFICATIONS:

1. RATING: DC 20V, 8A.
2. CONTACT RESISTANCE: $\leq 30m\Omega$; After test: $\leq 50m\Omega$
3. INSULATION RESISTANCE: 100M Ohms MIN. @ 500V DC
4. WITHSTANDING VOLTAGE: 500V AC 1 MINUTE.
5. INSERTION FORCE: 0.3Kgf TO 3.0 Kgf
6. EXTRACTION FORCE: 0.3Kgf TO 3.0 Kgf
7. LIFE TEST: 5000 CYCLES.
8. TO CONFORM TO THE SINGATRON HAZARDOUS SUBSTANCE FREE SPEC.
9. HALOGEN FREE PRODUCT IDENTIFICATION LABEL ON PACKAGING:
10. OTHER GENERAL SPEC. TO REFER "2DC1524-004111F SPEC"
11. PACKAGE: SEE "2DC1524-004111F" PACKAGE.
12. FOR REFLOW SOLDERING LEAD-FREE PROCESS.
13. 斜插 (破壞性) 測試: 帶線15cm進行45度角 上、下、左、右分別施加7kgf力, 持續5秒, 測試3次, 檢驗產品無破裂現象

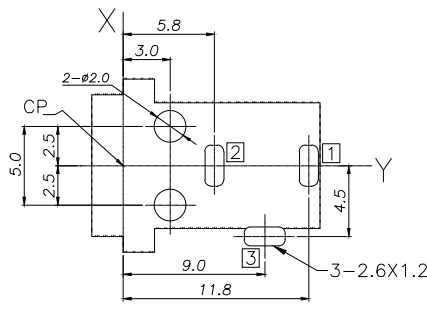
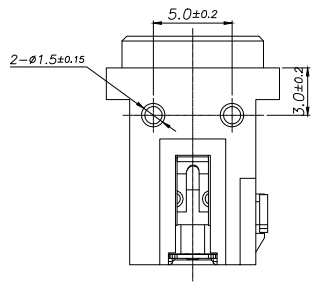

RECOMMENDED P. C. B. LAYOUT (T=1.2mm)
UNSPECIFIED TOLERANCE: ± 0.05
(TOP VIEW)

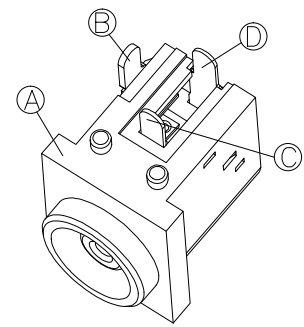

PART NO.

2DC1524-004111F

- SUFFIX: HALOGEN FREE
- PACKAGE: 1: TAPE & REEL
- HOUSING COLOR: 1: BLACK
- CONTACT PLATING: 1: TIN 120~200u", Ni 40~80u"

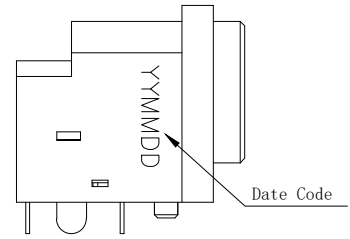
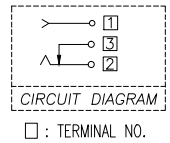
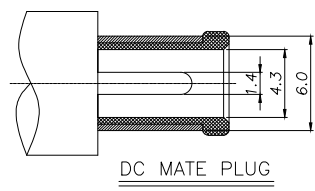

D	CENTER PIN	1	C2680R-H, 0.25t	TIN 120~200u", Ni 40~80u"
C	TIP SPRING	1	C5210R-EH, 0.25t	TIN 120~200u", Ni 40~80u"
B	SHUNT TERMINL	1	C2680R-1/2H 0.50t	TIN 120~200u", Ni 40~80u"
A	HOUSING	1	PA10T UL 94V-0	BLACK
NO	DESCRIPTION	QTY	MATERIAL	PLATING & COLOR

UNLESS OTHERWISE SPECIFIED TOLERANCES

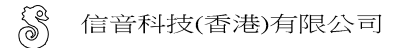

DECIMALS:	ANGLES:	TITLE	DC POWER JACK, R/A, DIP TYPE	
X : ± 0.5	X : $\pm 2^\circ$	DWN	EVEN 2023.09.01	PART NO. 2DC1524-004111F
X.X : ± 0.3	X.X : $\pm 1^\circ$	CHKD		SCALE 4:1 UNIT: mm
X.XX : ± 0.2		APVD	TEBESA 2023.09.04	SIZE: A3 SHEET: 1 OF 1 REV:C

CUSTOMER COPY