

REV.	ECN NO OR DESCRIPTION	REVISED	DATE
A	PDR RELEASE	IVY-C	2015.04.02

SPECIFICATIONS:

1. RATING: DC 18V, 5A.
2. CONTACT RESISTANCE: 50 mΩ MAX.
3. INSULATION RESISTANCE: 100M Ohms MIN. @500V DC.
4. WITHSTANDING VOLTAGE: 500V AC 1 MINUTE.
5. INSERTION FORCE: 0.3Kg TO 3.0 Kg
6. EXTRACTION FORCE: 0.3Kg TO 3.0 Kg
7. LIFE TEST: 5000 CYCLES.
8. TO CONFORM TO THE SINGATRON HAZARDOUS SUBSTANCE FREE SPEC.
9. GREEN PRODUCT IDENTIFICATION LABEL ON PACKAGING: **G.P. PASS**
10. PACKAGE: SEE "2DC1548 SERIES" PACKAGE.
11. FOR REFLOW SOLDERING LEAD-FREE PROCESS.
12. OTHER GENERAL SPEC. TO REFER "2DC1548 SERIES SPEC"

PART NO.

2DC1548-X0011H

- PIN :
 1: 1.0φ
 2: 1.3φ
- SUFFIX: HALOGEN
 - PACKAGE: 1: TAPE & REEL
 - HOUSING COLOR: 1: BLACK
 - CONTACT PLATING: 1: MATTE TIN PLATING

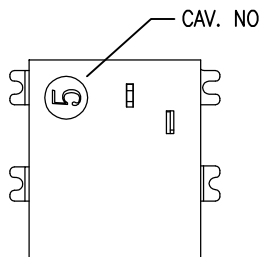
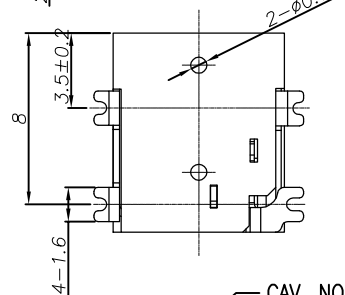
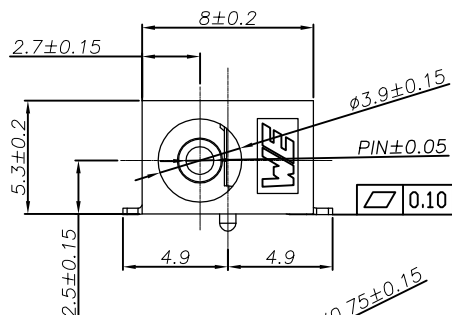
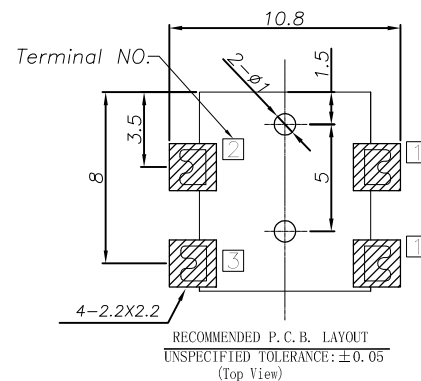
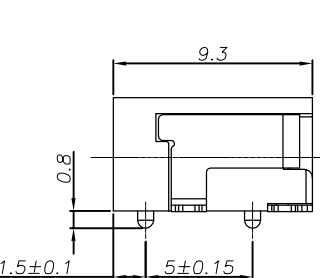

TOP VIEW

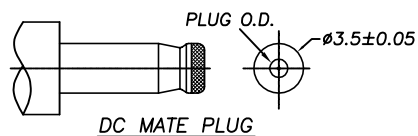
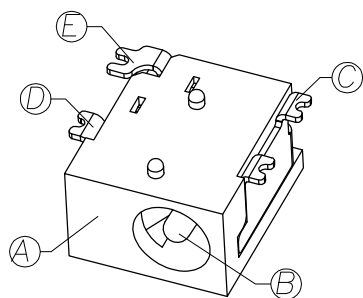
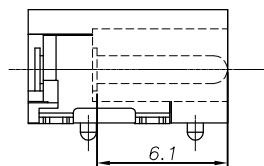

PIN	∅1.0	∅1.3
PLUG O.D.	1.05 ^{+0.10} _{-0.00}	1.35 ^{+0.10} _{-0.00}

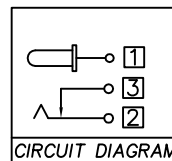

□ : TERMINAL NO.

E	SHUNT TERMINAL	1	BRASS 0.3t	MATTE TIN PLATING
D	TIP SPRING	1	PHOSPHOR BRONZE 0.3t	MATTE TIN PLATING
C	CENTER PIN TERMINAL	1	BRASS 0.3t	MATTE TIN PLATING
B	CENTER PIN	1	BRASS	GOLD FLASH
A	HOUSING	1	PA-9T UL 94V-0	BLACK

NO	DESCRIPTION	QTY	MATERIAL	PLATING & COLOR
UNLESS OTHERWISE SPECIFIED TOLERANCES			Singatron Enterprise Co., Ltd. 信音企業股份有限公司	
DECIMALS:		ANGLES:	TITLE: DC POWER JACK, SMT TYPE	
X	±0.5	X	±2°	DWN NY-C 2015.04.02 PART NO. 2DC1548-X0011H
X.X	±0.3	X.X	±1°	CHKD ANGEL/2015.04.02 SCALE 1:1 UNIT: mm
X.XX	±0.2			APVD ANGEL/2015.04.02 SIZE: A3 SHEET: 1 OF 1 REV: A
CUSTOMER COPY				