

REV.	ECN NO OR DESCRIPTION	REVISED	DATE
A	PDR NO:T210617-3A	Kesheng	2022.11.24

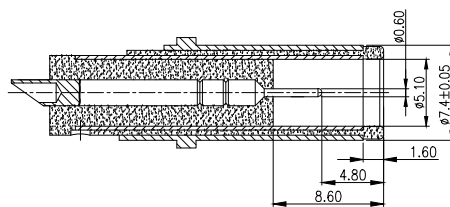

MATING PLUG: OD $\phi 7.4$; ID $\phi 0.6$
Tolerance: ± 0.05

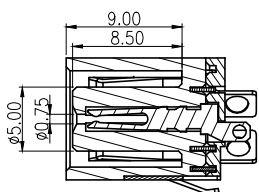
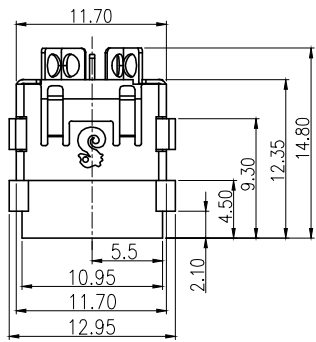

SECTION A-A

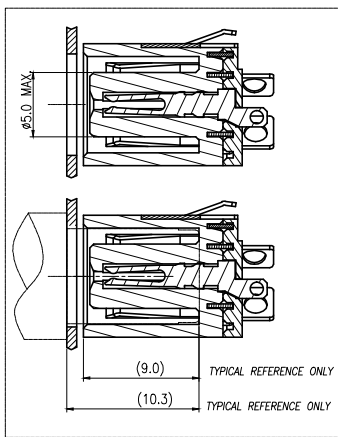

SPECIFICATIONS:

- ELECTRICAL CHARACTERISTICS:
 - RATING: 17A MAX.
 - RATING: 20V DC.
 - CONTACT RESISTANCE: 30M Ω Max.
 - INSULATION RESISTANCE: 100M Ω Min.
 - DIELECTRIC WITHSTANDING VOLTAGE: 150V AC FOR 1 MINUTE.
- MECHANICAL CHARACTERISTICS:
 - INSERTION FORCE :2.0KG MAX.
 - WITHDRAWAL FORCE : 0.7~2.0 KGF
- LIFE TEST: 15,000 CYCLES MIN.
- OPERATING TEMPERATURE:-40°C TO 85°C
- OTHER GENERAL SPEC. REFER TO "2DC2018-009111F".
- TO CONFORM TO SINGATRON HAZARDOUS SUBSTANCE FREE SPEC.
- HALOGEN FREE PRODUCT IDENTIFICATION MARK ON PRODUCT:
- HALOGEN FREE PRODUCT IDENTIFICATION LABEL ON PACKAGING:
- FOR HAND SOLDERING LEAD-FREE PROCESS.
- PACKAGING:BAG

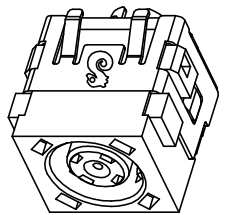
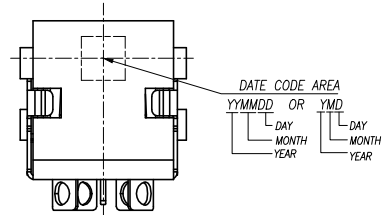
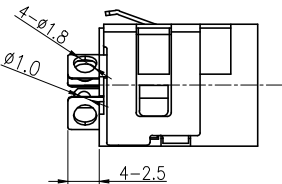
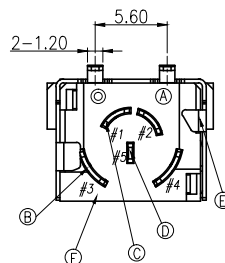
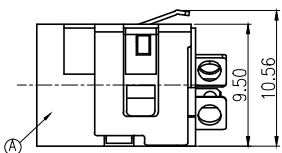
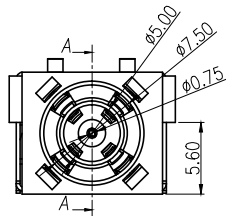
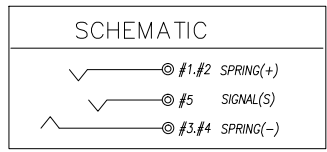

F	COVER	1	THERMOPLASTIC	BLACK
E	SHELL	1	COPPER ALLOY	NICKEL PLATING
D	SIGNAL(S)	1	COPPER ALLOY	Au 1u~3u" Min PLATED ON CONTACT AREA; MATTE Sn 120u" MIN. PLATED ON SOLDER AREA;
C	SPRING(+)	1	COPPER ALLOY	NICKEL 50u" MIN. PLATED ON OVER ALL.
B	SPRING(-)	1	COPPER ALLOY	
A	BODY	1	THERMOPLASTIC	BLACK
NO	DESCRIPTION	QTY	MATERIAL	PLATING & COLOR

UNLESS OTHERWISE SPECIFIED TOLERANCES		Singatron Enterprise Co., Ltd. 信音企業股份有限公司	
DECIMALS:	ANGLES:	TITLE DC POWER JACK	
X : ± 0.5	X : $\pm 2^\circ$	DWN	Kesheng PART NO.2DC2018-009111F
X.X : ± 0.3	X.X : $\pm 1^\circ$	CHKD	Lussen SCALE 1:1 UNIT: mm
X.XX : ± 0.2		APVD	Liao SIZE: A3 SHEET:1 OF 2 REV: A
CUSTOMER COPY			

REV.	ECN NO OR DESCRIPTION	REVISED	DATE
A	PDR NO:T210617-3A	Kesheng	2022.11.24

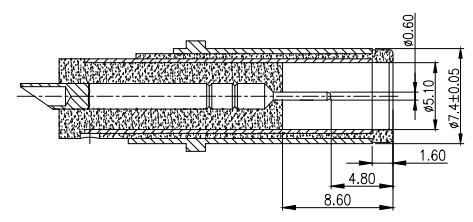
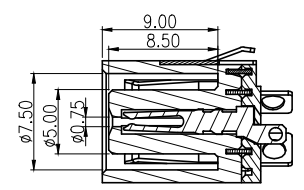
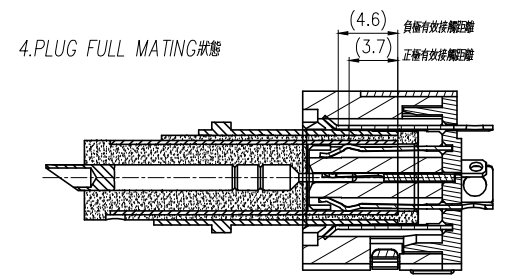
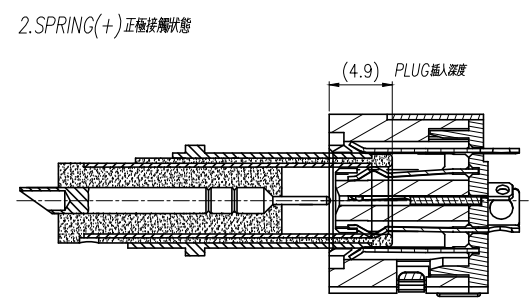
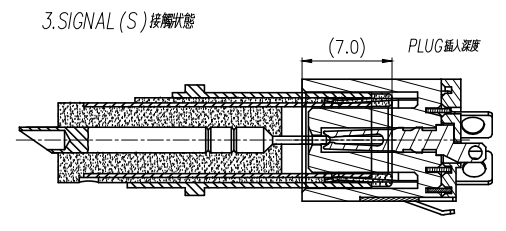
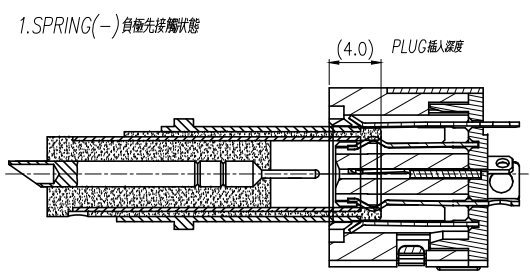

Tolerance: ± 0.05

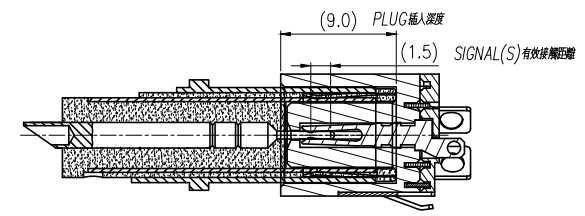

UNLESS OTHERWISE SPECIFIED TOLERANCES		Singatron Enterprise Co., Ltd. 信音企業股份有限公司	
DECIMALS:	ANGLES:	TITLE	DC POWER JACK
X : ± 0.5	X : $\pm 2^\circ$	DWN	Kesheng PART NO.2DC2018-009111F
X.X : ± 0.3	X.X : $\pm 1^\circ$	CHKD	Lussen SCALE 1:1 UNIT: mm
X.XX : ± 0.2		APVD	Liao SIZE: A3 SHEET:2 OF 2 REV: A
CUSTOMER COPY			