

REV	ECN NO	OR DESCRIPTION	REVISED	DATE
A	ECN: S180801-0-1		Qizhen	2018.11.01

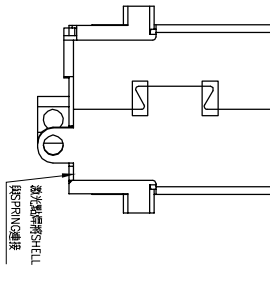
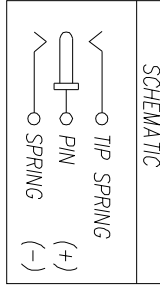
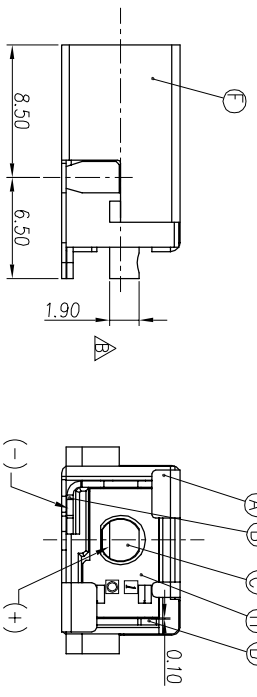
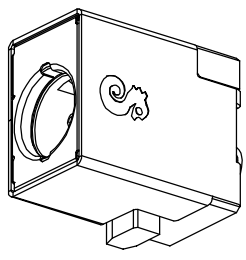
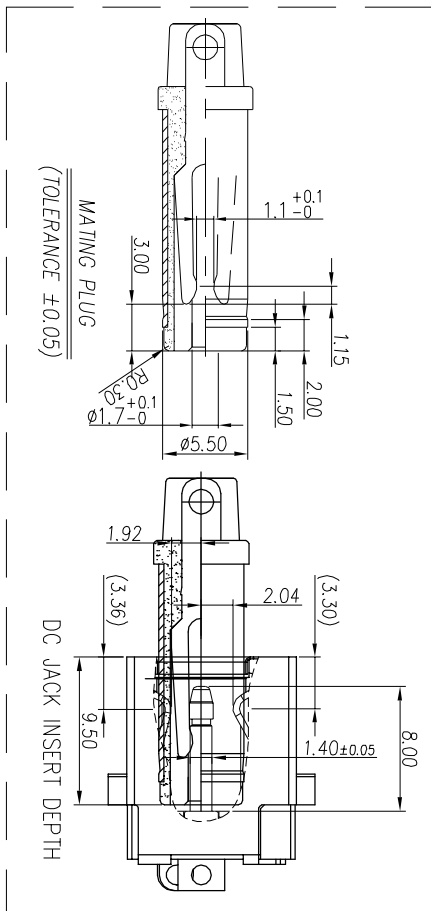
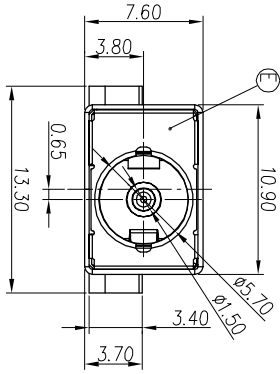
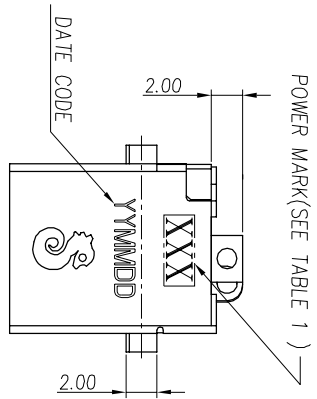

- SPECIFICATIONS:**
1. ELECTRICAL CHARACTERISTICS:
    - 1-1. RATING: 20V 7A
    - 1-2. CONTACT RESISTANCE: 10mΩ MAX.(INITIAL)
    - 1-3. DIELECTRIC WITHSTANDING VOLTAGE: 500V AC FOR ONE MINUTE.
    - 1-4. INSULATION RESISTANCE: 100mΩ MIN. MEASURED BY 500 VDC
  2. LIFE TEST: 5,000 CYCLES MIN.
  3. TO CONFORM TO SINGATRON HAZARDOUS SUBSTANCE FREE SPEC.
  4. HALOGEN FREE PRODUCT IDENTIFICATION MARK ON PRODUCT: ♻️
  5. HALOGEN FREE PRODUCT IDENTIFICATION LABEL ON PACKAGING: ♻️
  6. FOR HAND SOLDERING LEAD-FREE PROCESS.
  7. PACKAGING: BAG.

H	COVER	1	THERMOPLASTIC UL 94V-0	BLACK
G	STOPPER	1	THERMOPLASTIC UL 94V-0	BLACK
F	SHELL	1	STAINLESS STEELS	NICKEL-PLATED
E	GROUND	1	STAINLESS STEELS	N/A
D	TIP SPRING	1	COPPER ALLOY	300- $\mu$ M(10 <sup>-3</sup> in.) AT CONTACT AREA
C	PIN	1	BRASS	GOLD-PLATED(1~3 $\mu$ "")
B	SPRING	1	COPPER ALLOY	300- $\mu$ M(10 <sup>-3</sup> in.) AT CONTACT AREA
A	HOUSING	1	THERMOPLASTIC UL 94V-0	BLACK
NO	DESCRIPTION	QTY	MATERIAL	PLATING & COLOR

UNLESS OTHERWISE SPECIFIED TOLERANCES

Singatron Enterprise Co., Ltd.  
**信登企業股份有限公司**

DECIMALS:	ANGLES:	TITLE
X : ±0.5	X : ±2°	DC POWER JACK
X.X : ±0.3	X.X : ±1°	DWG Qizhen
X.XX : ±0.2		PART NO. 2DC2025-001111F
		SCALE 3:1 UNIT: mm
		SIZE: A3 SHEET: 1 OF 1 REV: A

CUSTOMER COPY