

SPECIFICATIONS:

- ELECTRICAL SPEC:
 - RATED CURRENT: 6.5A
 - RATED VOLTAGE: 20V
 - INSULATION RESISTANCE: 100M MIN. AFTER BY 500 VDC FOR 1 MINUTE
 - DIELECTRIC WITHSTANDING VOLTAGE: 500V AC FOR 1 MINUTE.
 - CONTACT RESISTANCE: 30mΩ MAX.(INITIAL)
- MECHANICAL SPEC:
 - INSERTION FORCE: 2.5kgf MAX.
 - WITHDRAWAL FORCE : 0.6~2.5kgf.
 - WEIGHT: 1.0 GRAM.
 - TEMPERATURE RISE CAN'T EXCEED 30°C MAX.
 - LIFE TEST(INSERTION/WITHDRAWAL): 5,000 CYCLES MIN.
 - OTHER GENERAL SPEC, PLEASE REFER TO "2DC3071 SERIES SPEC".
 - HALOGEN FREE PRODUCT IDENTIFICATION MARK ON JACK:
 - HALOGEN FREE PRODUCT IDENTIFICATION LABEL ON PACKAGING:
 - FOR REFLOW SOLDERING LEAD-FREE PROCESS.
 - THE PANEL'S ID MUST BE GREATER THAN THE PLUG'S OD WHICH MUST HAVE A DIFFERENCE OF LESS THAN OR EQUAL TO 0.50mm.(AS SHOWN IN FIGURE 1.)

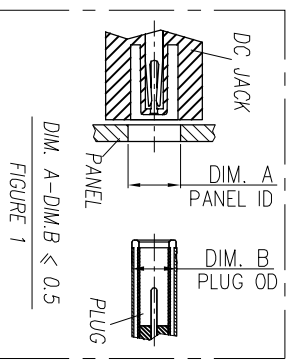
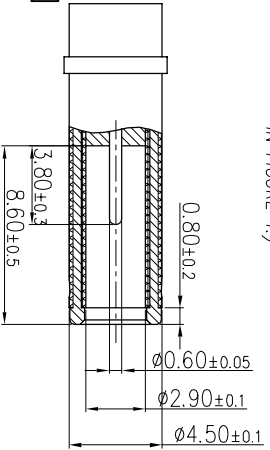
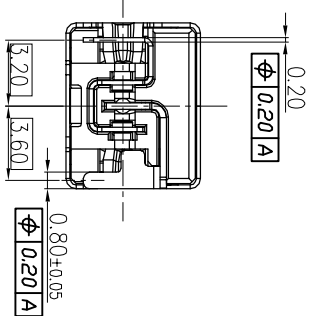
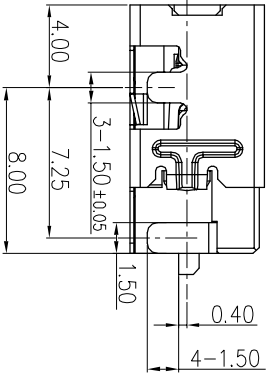
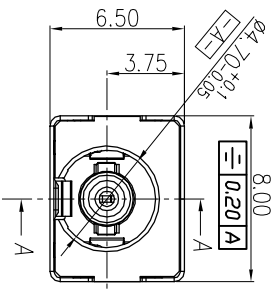

PLUG 型号 零件号 45P06CV230-1A00-01

MATING PLUG
TOLERANCE: X:XX: ±0.10

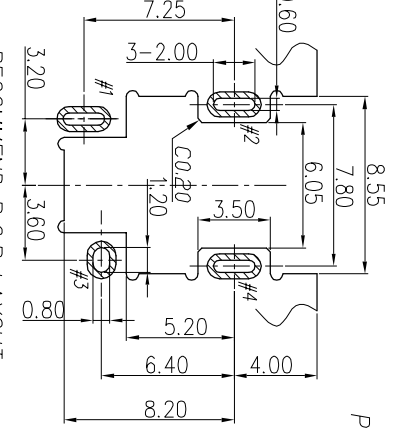
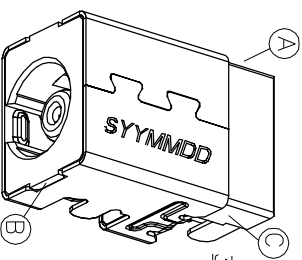
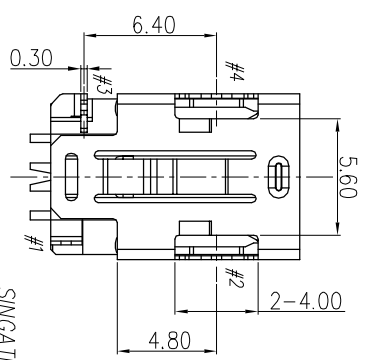

ITEM	DESCRIPTION	QTY	MATERIAL/THICK(mm)	FINISH
D	SIGNAL	1	COPPER ALLOY 0.30T	4U 50U MIN ON CONTACT AREA
C	SPRING+	1	COPPER ALLOY 0.20T	MATTE SN 80U MIN ON SOLDER TAIL.
B	SHELL	1	COPPER ALLOY 0.20T	ALL OVER IN 50U MIN.
A	BODY	1	HIGH TEMP. THERMOPLASTIC UL 94V-0	NI 60U MIN.

UNLESS OTHERWISE SPECIFIED TOLERANCES
 Singatron Enterprise Co., Ltd.
 信登企業股份有限公司

DECIMALS:	ANGLES:	TITLE
X : ±0.5	X : ±2°	DC POWER JACK
XX : ±0.3	XX : ±1°	
XXX : ±0.2		

CHKD	APVD	PART NO.	SCALE	UNIT	SHEET	REV.
Ron	Lussen	2DC3071-041111F	4:1	mm	1 OF 2	A

CUSTOMER COPY

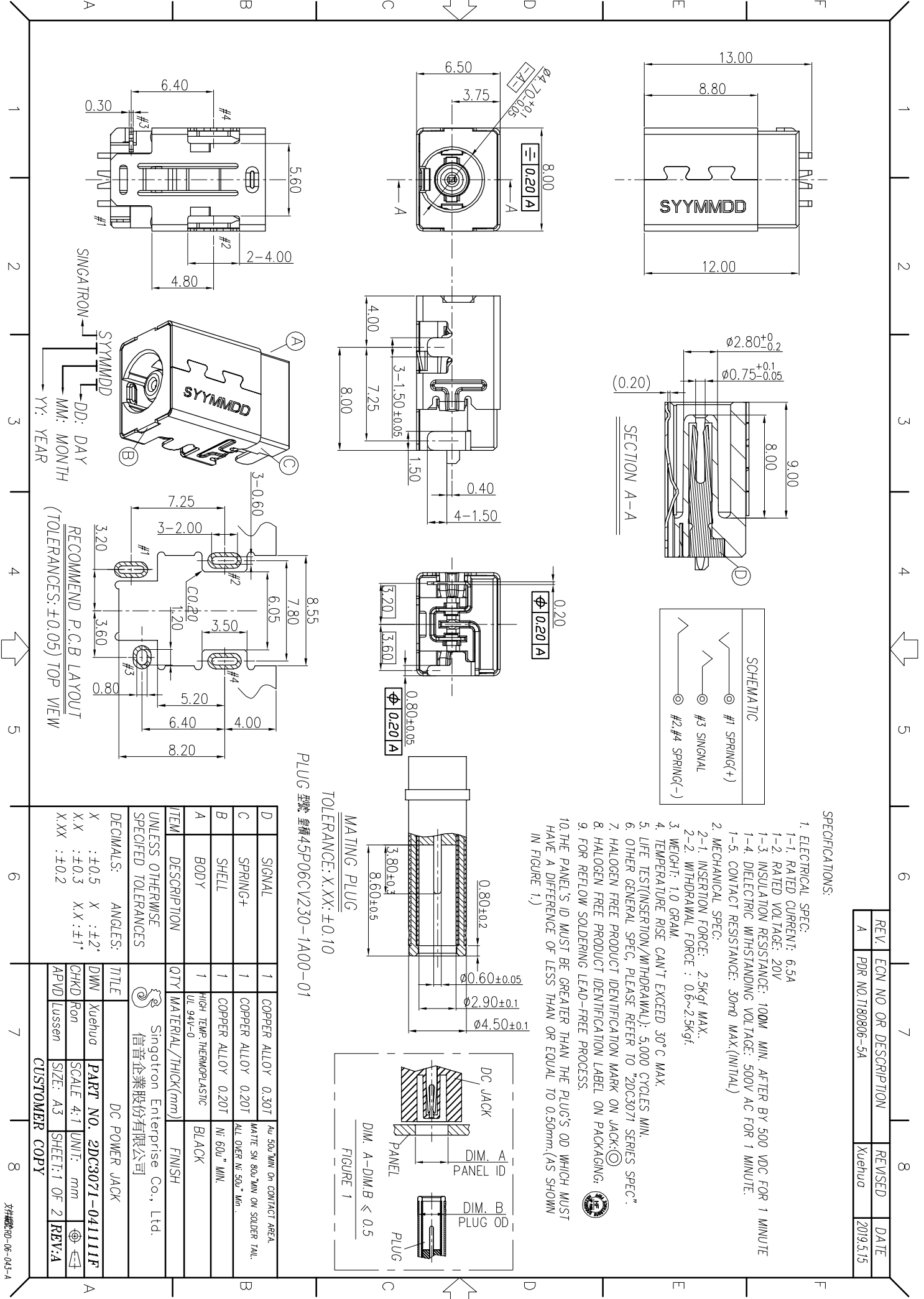

REV.	ECN NO OR DESCRIPTION	REVISED	DATE
A	PDR NO T180806-5A	Xuehua	2019.5.15

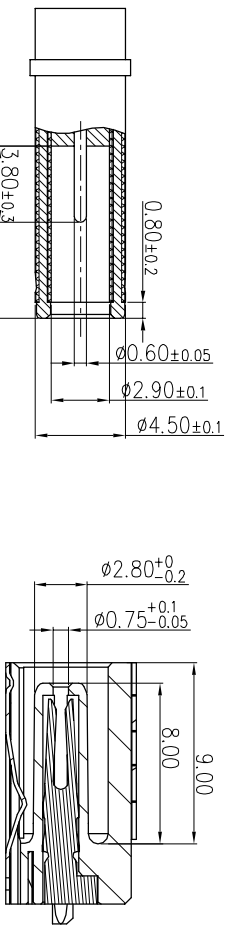

MATING PLUG
 TOLERANCE: X.XX: ±0.10
 PLUG 型号: 皇朝45P06CV230-1A00-01
 PART NO. 2DC3071-041111F

4. LOCK POSITION

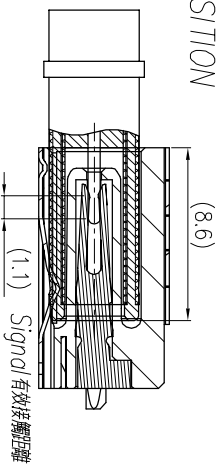

1. NEGATIVE CONTACT FIRST

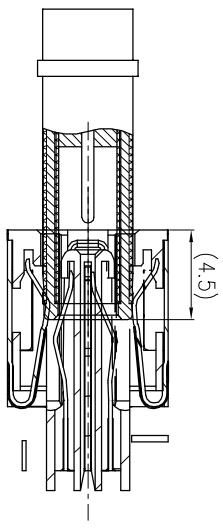

5. FULL INSERTION

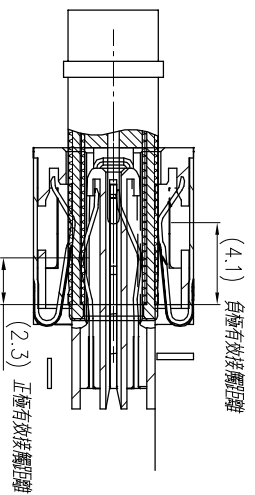

2. POSITIVE CONTACT

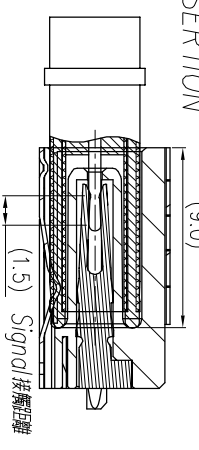

3. SIGNAL CONTACT

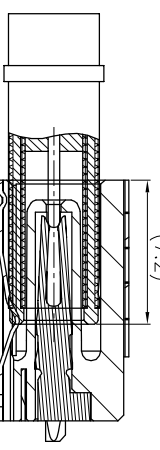
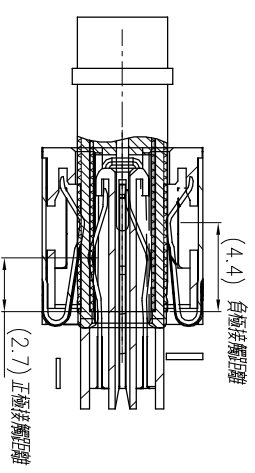

ITEM	DESCRIPTION	QTY	MATERIAL/THICK(mm)	FINISH
UNLESS OTHERWISE SPECIFIED TOLERANCES				
信源企業股份有限公司 Singgatron Enterprise Co., Ltd.				
DECIMALS:		ANGLES:		
X	:±0.5	X	:±2°	
XX	:±0.3	XX	:±1°	
XXX	:±0.2			
TITLE		DC POWER JACK		
DWM	Xuehua	PART NO.	2DC3071-041111F	
CHKD	Ron	SCALE	4:1	UNIT: mm
APVD	Lussen	SIZE:	A3	SHEET: 2 OF 2
REV: A				
CUSTOMER COPY				