

REV.	ECN NO OR DESCRIPTION	REVISED	DATE
A	PDR NO. T170420-2A	Ron	2017.09.09

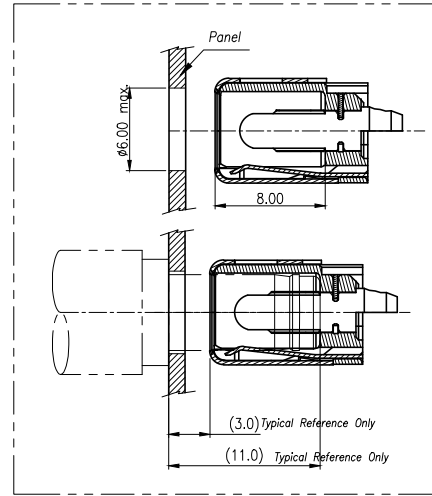
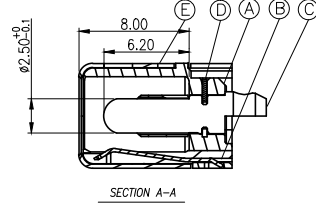
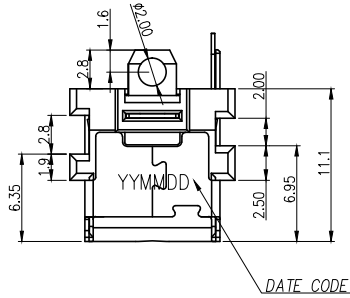

SPECIFICATIONS:

- ELECTRICAL CHARACTERISTICS:
  - 1-1. RATING: 20V 10A
  - 1-2. CONTACT RESISTANCE: 15mΩ MAX.
  - 1-3. DIELECTRIC WITHSTANDING VOLTAGE: 500V AC FOR ONE MINUTE.
  - 1-4. INSULATION RESISTANCE: 100MΩ MIN. MEASURED BY 500 VDC
- MECHANICAL CHARACTERISTICS:
  - 2-1. INSERTION FORCE : 0.8~2.0 kgf (INITIAL / AFTER LIFE TEST)
  - 2-2. WITHDRAWAL FORCE : 0.8~2.0 kgf (INITIAL / AFTER LIFE TEST)
- TEMPERATURE RISE CAN'T EXCEED 30°C
- LIFE TEST: 8,000 CYCLES MIN.
- WEIGHT : 1.98 g
- OTHER GENERAL SPEC. TO REFER "2DC3156 SERIES SPEC".
- TO CONFORM TO SINGATRON HAZARDOUS SUBSTANCE FREE SPEC.
- HALOGEN FREE PRODUCT IDENTIFICATION MARK ON JACK: (C)
- HALOGEN FREE PRODUCT IDENTIFICATION LABEL ON PACKAGING: (C)
- FOR HAND SOLDERING LEAD-FREE PROCESS.
- PRINTED DATE CODE "YYMMDD" ON TOP OF CONNECTOR.

DD: DAY  
MM: MONTH  
YY: YEAR

SCHEMATIC

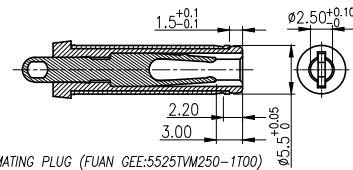
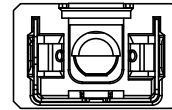
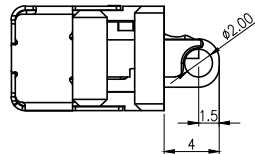
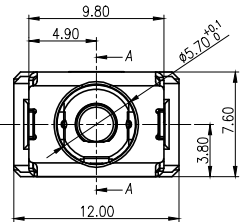
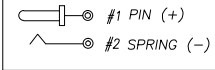

MATING PLUG (FUJAN GEE:5525VM250-1T00)  
TOLERANCE: X.XX:0.10

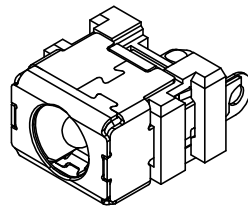
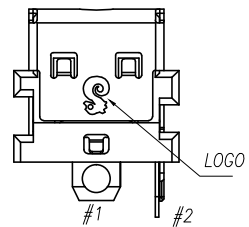

ITEM	DESCRIPTION	QTY	MATERIAL	PLATING & COLOR
E	SHELL	1	STAINLESS 0.3T (SUS 304)	Ni 60u" MIN.
D	TERMINAL	1	STAINLESS 0.3T (SUS 301)	N/A
C	PIN	1	BRASS BAR(HBI59-1.5B)	GOLD FLASH OVER Ni 50u"
B	SPRING	1	PHOSPHOR BRONZE (CS210-EH 0.25T)	MATTE Sn 120u" OVER Ni 60u"
A	BODY	1	PA 4T +30%GF UL 94V-0	BLACK

UNLESS OTHERWISE SPECIFIED TOLERANCES		Singatron Enterprise Co., Ltd. 信音企業股份有限公司	
DECIMALS:	ANGLES:	TITLE	
X :±0.5	X :±2°	DWN	Ron PART NO.2DC3156-004111F
X.X :±0.3	X.X :±1°	CHKD	SKY SCALE -- UNIT: mm
X.XX :±0.2		APVD	Lussen SIZE: A3 SHEET:1 OF 2 REV: A
CUSTOMER COPY			

REV.	ECN NO OR DESCRIPTION	REVISED	DATE
A	PDR NO. T170420-2A	Ron	2017.09.09

1. 負極接觸狀態:

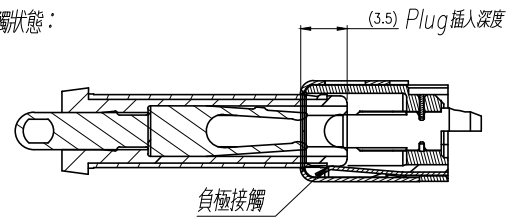

2. 正極接觸狀態:

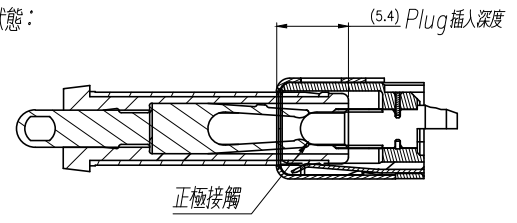

3. Lock 狀態狀態:

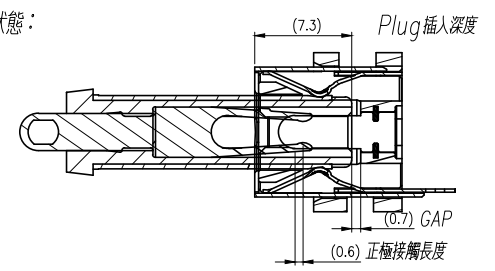

4. Full Mating 狀態:

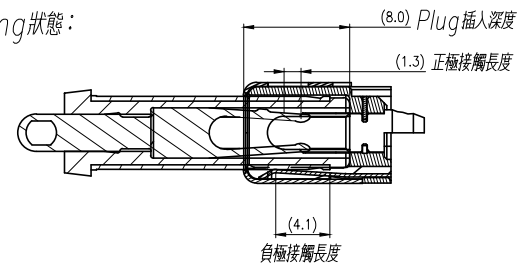

ITEM	DESCRIPTION	QTY	MATERIAL	PLATING & COLOR
UNLESS OTHERWISE SPECIFIED TOLERANCES		Singatron Enterprise Co., Ltd. 信音企業股份有限公司		
DECIMALS:	ANGLES:	TITLE	DC POWER JACK_MATING DRAWING	
X :±0.5	X :±2°	DWN	Ron	<b>PART NO.2DC3156-004111F</b>
X.X :±0.3	X.X :±1°	CHKD		SCALE -- UNIT: mm
X.XX :±0.2		APVD		SIZE: A3 SHEET:2 OF 2 REV: A
<b>CUSTOMER COPY</b>				