

MATING PLUG (TUAN GEE:55251TW250-1100)
TOLERANCE: X:XX:0.10

- SCHEMATIC
-
- SPECIFICATIONS:
- ELECTRICAL CHARACTERISTICS:
 - 1-1. RATING: 20V 10A
 - 1-2. CONTACT RESISTANCE: 15mΩ MAX.
 - 1-3. DIELECTRIC WITHSTANDING VOLTAGE: 500V AC FOR ONE MINUTE.
 - 1-4. INSULATION RESISTANCE: 100MΩ MIN. MEASURED BY 500 VDC.
 - MECHANICAL CHARACTERISTICS:
 - 2-1. INSERTION FORCE: 0.8-2.0 N_g (INITIAL / AFTER LIFE TEST)
 - 2-2. WITHDRAWAL FORCE: 0.8-2.0 N_g (INITIAL / AFTER LIFE TEST)
 - 2-3. TEMPERATURE RISE: CAN'T EXCEED 50°C
 - 2-4. LIFE TEST: 8000 CYCLES MIN.
 - 2-5. MECHAN: 2.1/2.9
 - OTHER SPEC. REFER TO DC POWER JACK GENERAL SPEC. FOR ASUS™.
 - TO CONFORM TO SINGAPORE HAZARDOUS SUBSTANCE FREE SPEC.
 - HALOGEN FREE PRODUCT IDENTIFICATION MARK ON JACK: (H)
 - HALOGEN FREE PRODUCT IDENTIFICATION LABEL ON PACKAGING: (H)
 - FOR REFLOW SOLDERING LEAD-FREE PROCESS.
 - PRINTED DATE CODE "YMMDD" ON TOP OF CONNECTOR.

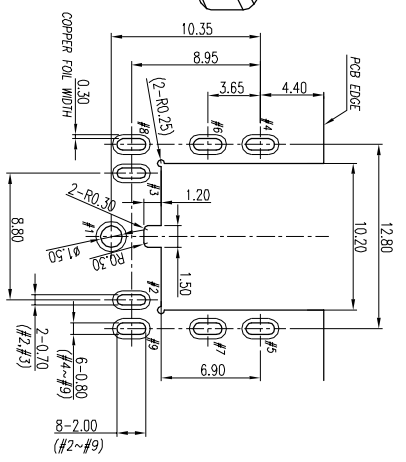
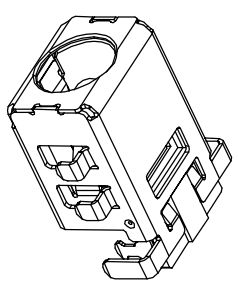
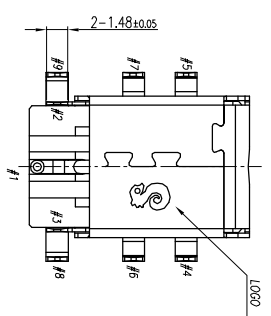

E	SHELL (GND)	1	STAINLESS (SUS 430)	Ni: 60u"
D	TERMINAL	1	STAINLESS (SUS 301)	N/A
C	PIN(+)	1	BRASS BAR(HB59)	GOLD FLASH OVER Ni: 60"
B	SPRING(-)	1	PHOSPHOR BRONZE (C5210)	MATTE Sn120u" OVER Ni: 60u"
A	BODY	1	PA 4T UL 94V-0	BLACK

UNLESS OTHERWISE SPECIFIED TOLERANCES

Singtron Enterprise Co., Ltd.
信登企業股份有限公司

DECIMALS:	ANGLES:	TITLE	Ø5.5 DC POWER JACK
X : ±0.5	X : ±2°	DWN Allen	PART NO. 2DC3158-002111F
X.X : ±0.3	X.X : ±1°	CHKD Sky	SCALE 4:1 UNIT: mm
X.XX : ±0.2		APVD Lussen	SIZE: A3 SHEET: 1 OF 2 REV: A

CUSTOMER COPY

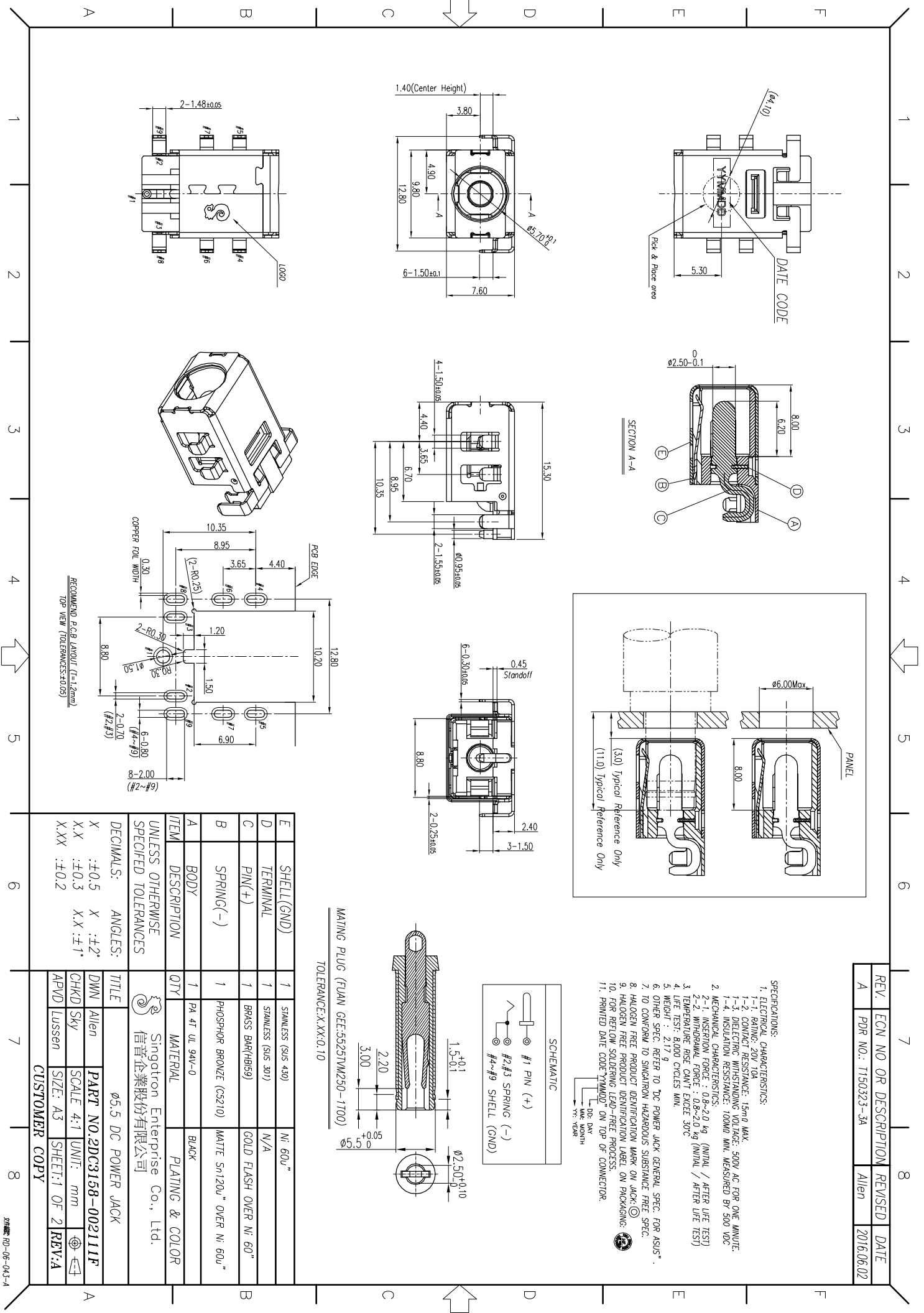

REV.	ECN NO OR DESCRIPTION	REVISED	DATE
A	PDR NO.: T150323-34	Allen	2016.06.02

REV.	ECN NO OR DESCRIPTION	REVISED	DATE
A	PDR NO.: 1150323-34	Allen	2016.06.02

1. 負極接觸狀態:

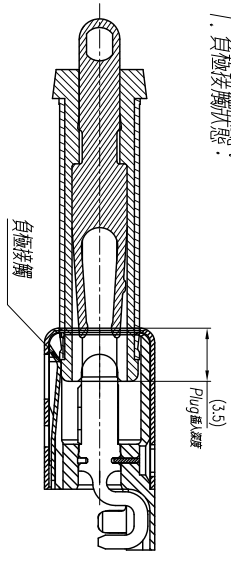

2. 正極接觸狀態:

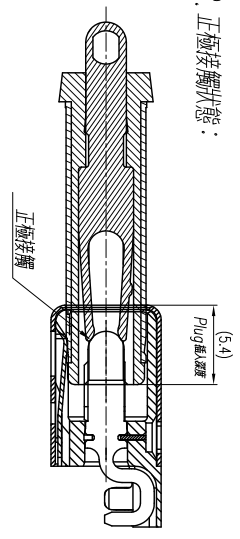

3. Lock 狀態:

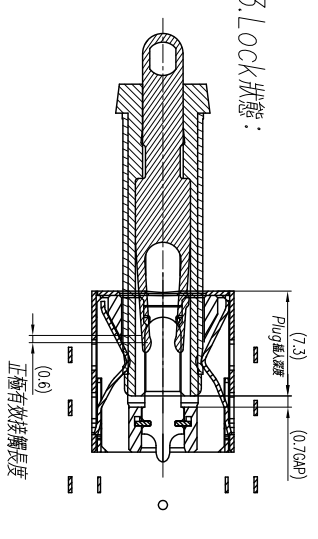

4. Full Mating 狀態:

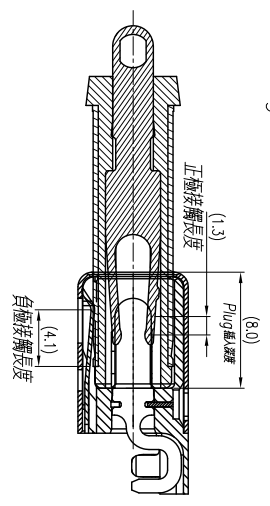

ITEM	DESCRIPTION	QTY	MATERIAL	PLATING & COLOR
	UNLESS OTHERWISE SPECIFIED TOLERANCES:			
	DECIMALS:			
X	:±0.5	X	:±2°	
X.X	:±0.3	X.X	:±1°	
X.XX	:±0.2			
	TITLE			
	DWN Allen			
	CHKD Sky			
	APVD Lussen			

 Singatron Enterprise Co., Ltd.
 信晉企業股份有限公司
 PART NO. 2DC3158-002111F
 SCALE 4:1 UNIT: mm
 SIZE: A3 SHEET: 2 OF 2 REV: A

CUSTOMER COPY