

REV.	ECN NO. OR DESCRIPTION	REVISED	DATE
A	PDR No.: T150806-1A	Wenshuo	2016.09.02

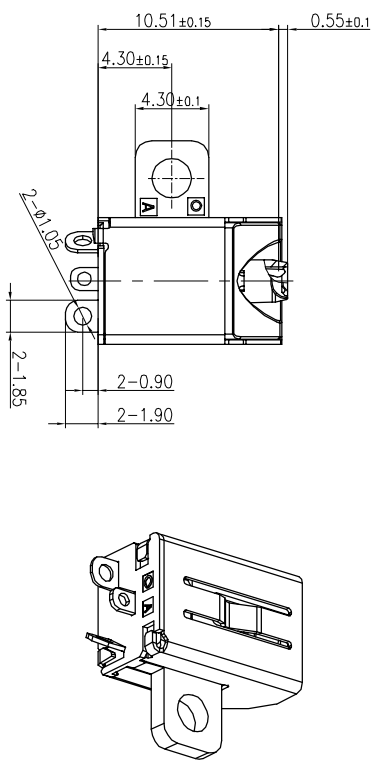

- SPECIFICATIONS:
- ELECTRICAL CHARACTERISTICS:
 - RATING: 20V 7A
 - CONTACT RESISTANCE: 30mΩ MAX.
 - DIELECTRIC WITHSTANDING VOLTAGE: 500V AC FOR ONE MINUTE.
 - INSULATION RESISTANCE: 100MΩ/MIN. MEASURED BY 500 VDC.
 - MECHANICAL CHARACTERISTICS:
 - INSERTION FORCE: 2.0 kgf MAX.
 - WITHDRAWAL FORCE: 0.7~2.0kgf (Initial): 0.6~2.0kgf (After Life Test)
 - TEMPERATURE RISE CAN'T EXCEED 30C
 - LIFE TEST: 15,000 CYCLES.
 - WEIGHT: 0.3904g
 - TO CONFORM TO SINGATRON HAZARDOUS SUBSTANCE FREE SPEC.
 - GREEN PRODUCT IDENTIFICATION MARK ON JACK:
 - GREEN PRODUCT IDENTIFICATION LABEL ON PACKAGING:
 - FOR HAND SOLDERING LEAD-FREE PROCESS
 - PRINTED DATE CODE: "ON TOP OF CONNECTOR"

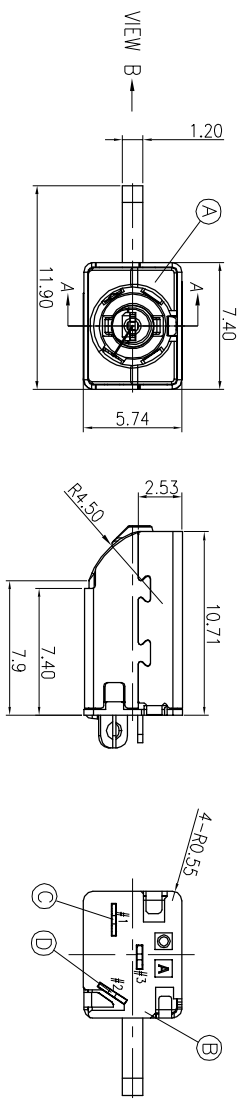
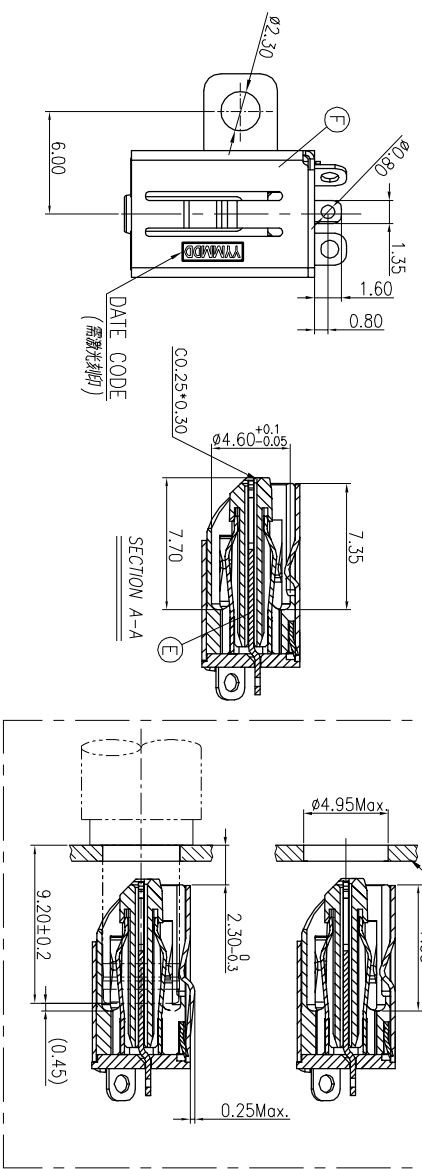
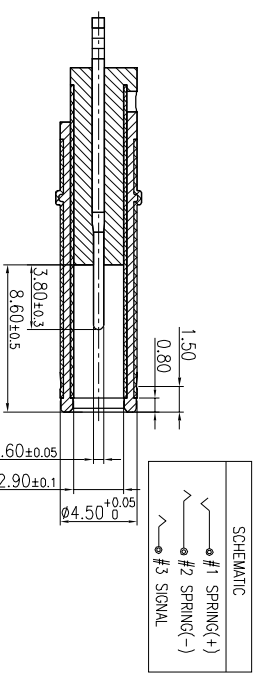

MATING PLUG/CABLE: GEE45P06C230-1A00-011
TOLERANCE: XX±0.10

NO	DESCRIPTION	QTY	MATERIAL	PLATING & COLOR
F	SHELL	1	STAINLESS STEEL 0.25T	# Ni: 60u"
E	SIGNAL	1	COPPER ALLOY 0.30T	Au 3u" ON CONTACT AREA MATE Sn 120u" ON SOLDER TAIL. ALL OVER IN 60u"
D	NEGATIVE	1	COPPER ALLOY 0.25T	MATE Sn 120u" OVER IN 60u"
C	POSITIVE	1	COPPER ALLOY 0.20T	MATE Sn 120u" OVER IN 60u"
B	COVER	1	HIGH TEMP-THERMOPLASTIC (HALOGEN FREE)UL 94V-0	BLACK
A	BODY	1	THERMOPLASTIC (HALOGEN FREE)UL 94V-0	BLACK

UNLESS OTHERWISE SPECIFIED TOLERANCES

Singatron Enterprise Co., Ltd.
信登企業股份有限公司

DECIMALS:	ANGLES:
X : ±0.5	X : ±2°
X.X : ±0.3	X.X : ±1°
X.XX : ±0.2	

TITLE	DC POWER JACK
DWM	Wenshuo
CHKD	
APVD	
PART NO.	2DC3165-006114F
SCALE	4:1
UNIT:	mm
SIZE:	A3
SHEET:	1 OF 2
REV:	A

CUSTOMER COPY

REV.	ECN NO OR DESCRIPTION	REVISED	DATE
A	PDR No.:1750806-1A	Wenshuo	2016.09.02

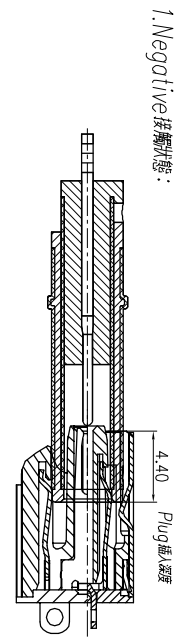

2. Positive 接觸狀態:

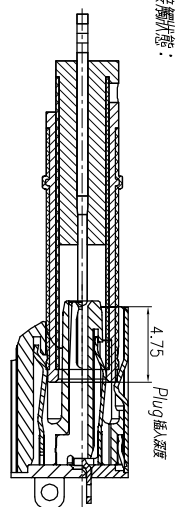

3. Signal 接觸狀態:

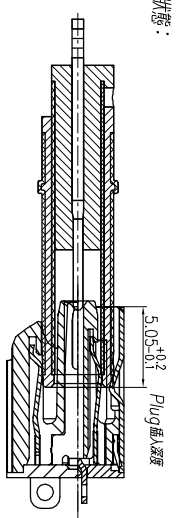

4. Negative Lock 狀態:

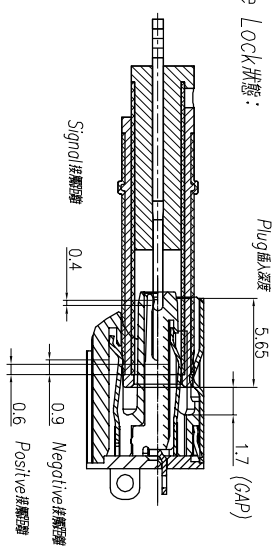

5. Shell (ground) 接觸狀態:

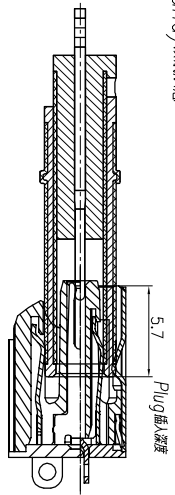

6. Shell Lock 狀態:

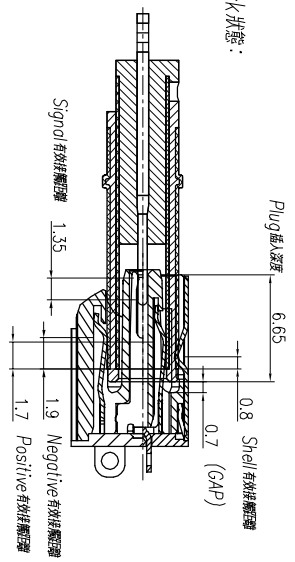

7. Plug 插至定位狀態:

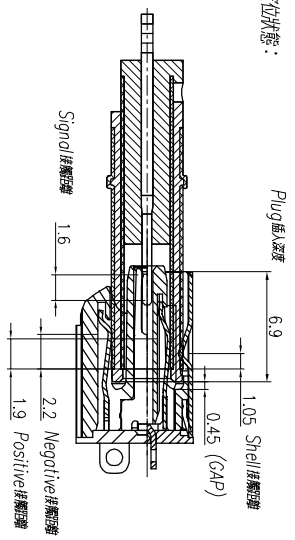

ITEM	DESCRIPTION	QTY	MATERIAL	PLATING & COLOR
	UNLESS OTHERWISE SPECIFIED TOLERANCES		Singatron Enterprise Co., Ltd. 信音企業股份有限公司	
DECIMALS:	ANGLES:			
X : ±0.5	X : ±2°			
X.X : ±0.3	X.X : ±1°			
X.XX : ±0.15				
TITLE	DC POWER JACK_MATING DRAWING			
DWN	Wenshuo PART NO. 2DC3165-006114F			
CHKD	SCALE 4:1 UNIT: mm			
APVD	SIZE: A3 SHEET: 2 OF 2 REV: 4			
CUSTOMER COPY				