

REV.	ECN NO OR DESCRIPTION	REVISED	DATE
A	PDR No.:T190909-5A	Zhijun	2019.01.10

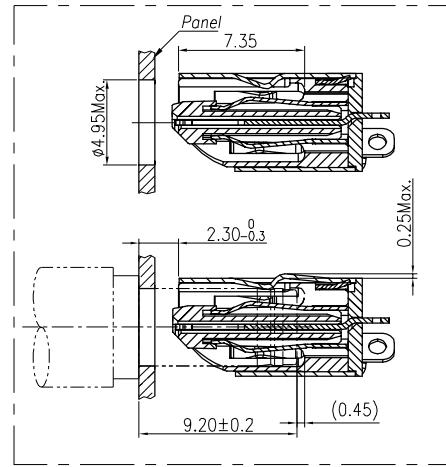
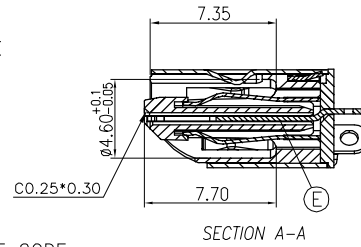
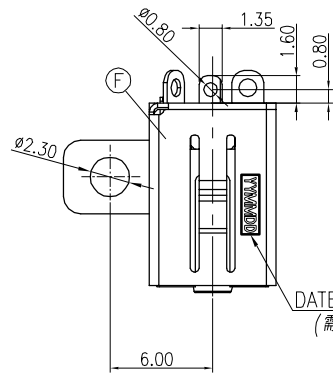

SPECIFICATIONS:

- ELECTRICAL CHARACTERISTICS:
 - RATING: 20V 7A
 - CONTACT RESISTANCE: 30mΩ MAX.
 - DIELECTRIC WITHSTANDING VOLTAGE: 500V AC FOR ONE MINUTE.
 - INSULATION RESISTANCE: 100MΩ MIN. MEASURED BY 500VDC
- MECHANICAL CHARACTERISTICS:
 - INSERTION FORCE: 2.0 Kgf MAX.
 - WITHDRAWAL FORCE: 0.7~2.0Kgf.(Initial);0.6~2.0Kgf.(After Life Test)
- TEMPERATURE RISE CAN'T EXCEED 30C
- LIFE TEST: 15,000 CYCLES.
- WEIGHT: 0.904g
- TO CONFORM TO SINGATRON HAZARDOUS SUBSTANCE FREE SPEC.
- GREEN PRODUCT IDENTIFICATION MARK ON JACK:
- GREEN PRODUCT IDENTIFICATION LABEL ON PACKAGING:
- FOR HAND SOLDERING LEAD-FREE PROCESS.
- PRINTED DATE CODE "YYMMDD" ON TOP OF CONNECTOR

DD: DAY
MM: MONTH
YY: YEAR

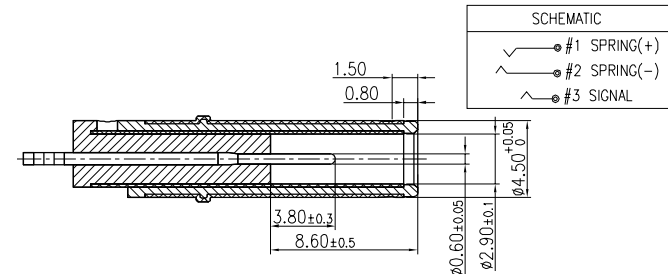
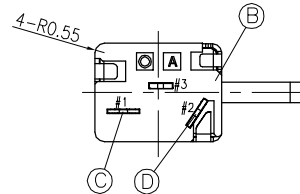
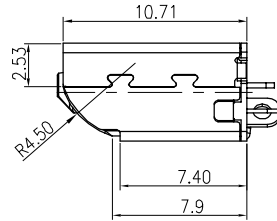
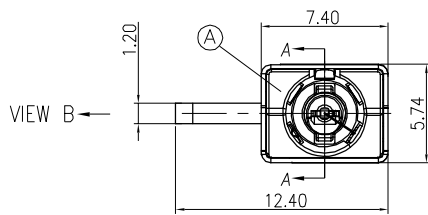

MATING PLUG(FUAN GEE:45P06CV230-1A00-01)
TOLERANCE:X.XX:±0.10

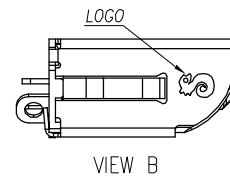
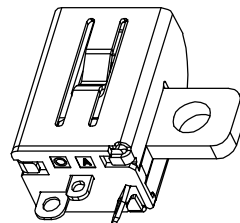
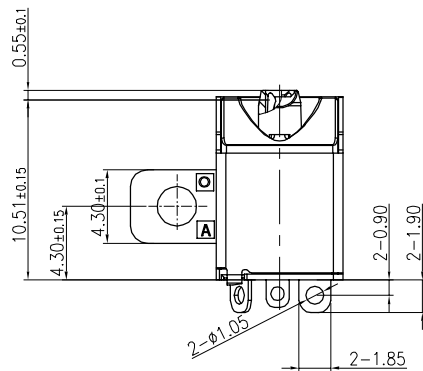

F	SHELL	1	STAINLESS STEEL 0.25T	黑Ni 60u"
E	SIGNAL	1	COPPER ALLOY 0.30T	Au 3u" ON CONTACT AREA; MATTE Sn 120u" ON SOLDER TAIL; ALL OVER Ni 60u"
D	NEGATIVE	1	COPPER ALLOY 0.25T	MATTE Sn 120u" OVER Ni 60u"
C	POSITIVE	1	COPPER ALLOY 0.20T	MATTE Sn 120u" OVER Ni 60u"
B	COVER	1	HIGH TEMP.THERMOPLASTIC (HALOGEN FREE)UL 94V-0	BLACK
A	BODY	1	THERMOPLASTIC (HALOGEN FREE)UL 94V-0	BLACK
NO	DESCRIPTION	QTY	MATERIAL	PLATING & COLOR

UNLESS OTHERWISE SPECIFIED TOLERANCES

Singatron Enterprise Co., Ltd.
信音企業股份有限公司

DECIMALS: ANGLES:
X :±0.5 X :±2°
X.X :±0.3 X.X :±1°
X.XX :±0.2

TITLE	DC POWER JACK		
DWN	Zhijun	PART NO.	2DC3165-013114F
CHKD	Sky	SCALE 4:1	UNIT: mm
APVD	Lussen	SIZE: A3	SHEET:1 OF 2

CUSTOMER COPY

REV.	ECN NO OR DESCRIPTION	REVISED	DATE
A	PDR No.:T190909-5A	Zhijun	2020.01.10

1. Negative 接觸狀態:

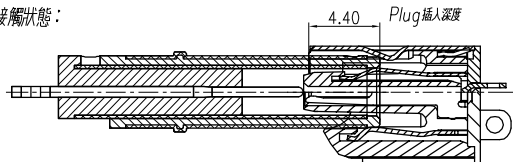

5. Shell (ground) 接觸狀態:

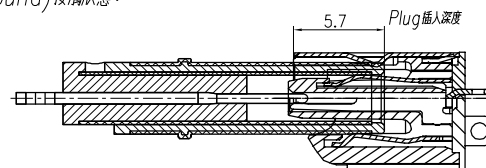

2. Positive 接觸狀態:

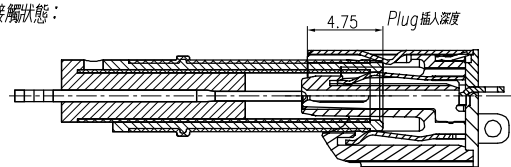

6. Shell Lock 狀態:

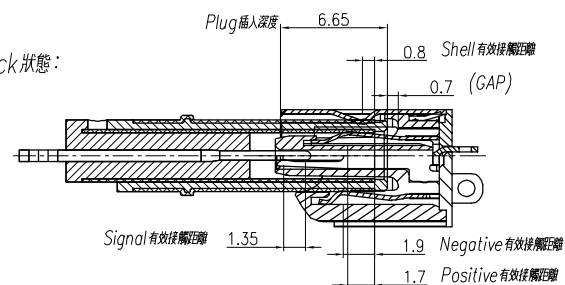

3. Signal 接觸狀態:

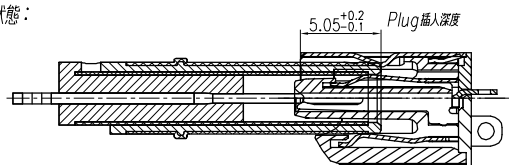

7. Plug 插至定位狀態:

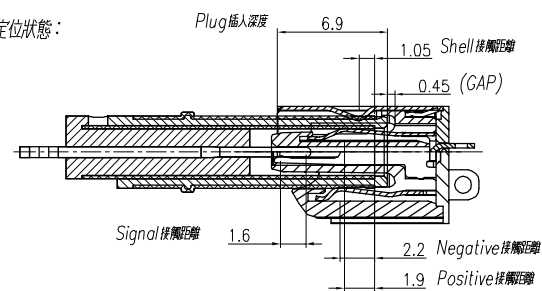

4. Negative Lock 狀態:

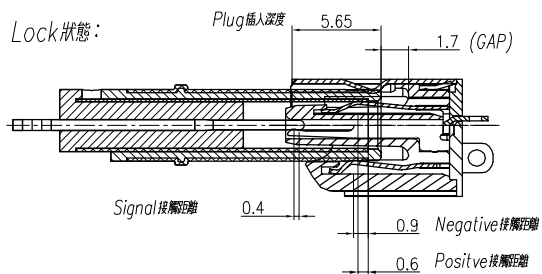

ITEM	DESCRIPTION	QTY	MATERIAL	PLATING & COLOR
UNLESS OTHERWISE SPECIFIED TOLERANCES			Singatron Enterprise Co., Ltd. 信音企業股份有限公司	
DECIMALS: X :±0.5 X.X :±0.3 X.XX :±0.15		TITLE DC POWER JACK_MATING DRAWING		
ANGLES: X :±2° X.X :±1°		DWN Zhijun	PART NO. 2DC3165-013114F	
		CHKD Sky	SCALE 4:1	UNIT: mm
		APVD Lussen	SIZE: A3	SHEET: 2 OF 2
CUSTOMER COPY				
REV: A				