

MATING PLUG
TOLERANCE: ±0.05

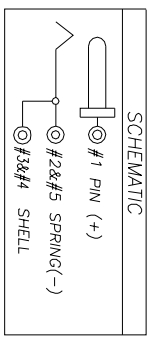

DD: DAY
MM: MONTH
YY: YEAR

- SPECIFICATIONS:
- ELECTRICAL CHARACTERISTICS:
 - RATING: 25V D.C.; 5.7A MAX.
 - CONTACT RESISTANCE: 30mΩ MAX.
 - DIELECTRIC WITHSTANDING VOLTAGE: 500V AC FOR ONE MINUTE.
 - INSULATION RESISTANCE: 100MΩ MIN. MEASURED BY 500 VDC.
 - MECHANICAL CHARACTERISTICS:
 - INSERTION FORCE: 2.0 KGf MAX.
 - WITHDRAWAL FORCE: 0.70 KGf MIN.
 - TEMPERATURE RISE CAN'T EXCEED 30°C
 - LIFE TEST: 10,000 CYCLES MIN.
 - TO CONFORM TO SINGATRON HAZARDOUS SUBSTANCE FREE SPEC.
 - HALOGEN FREE PRODUCT IDENTIFICATION MARK ON JACK: (C)
 - HALOGEN FREE PRODUCT IDENTIFICATION LABEL ON PACKAGING: (S)
 - FOR HAND SOLDERING LEAD-FREE PROCESS.
 - PRINTED DATE CODE "YYMMDD" ON TOP OF CONNECTOR.

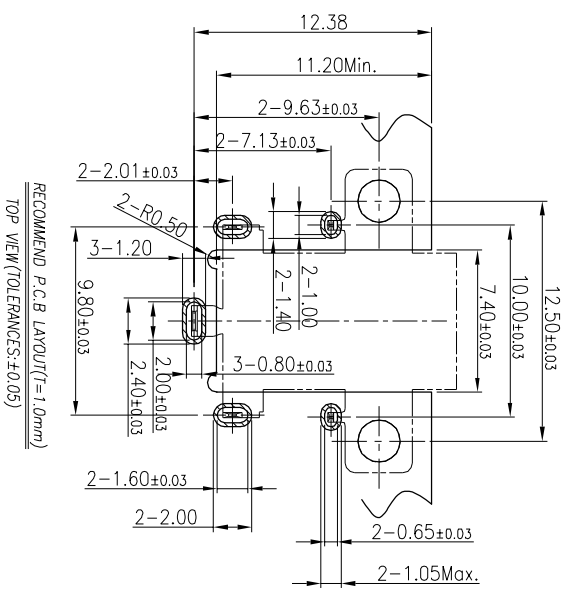
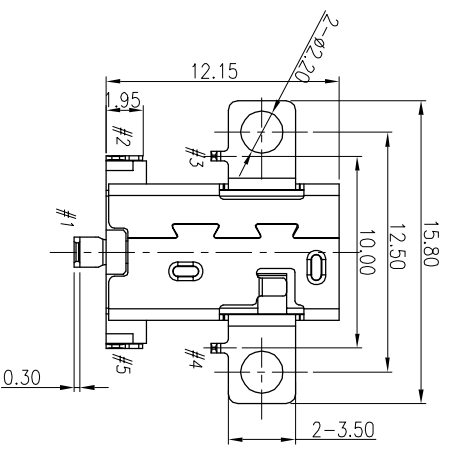

D	SHELL	1	STAINLESS 0.30T	Ni 60u"MIN.
C	SPRING(-)	1	TI-COPPER 0.25T	MATTE Sn 100u"MIN, OVER Ni50u"MIN
B	CENTER PIN	1	PHOSPHOR BRONZE 0.30T	GOLD FLASH ON CONTACT AREA MATTE Sn 120u" ON SOLDER TAIL ALL OVER Ni 50u" MIN
A	BODY	1	HIGH TEMP. TERNOPLASTIC UL 94V-0	BLACK
ITEM	DESCRIPTION	QTY	MATERIAL	PLATING & COLOR

Singatron Enterprise Co., Ltd.
信音企業股份有限公司

DECIMALS:	ANGLES:	TITLE	DC POWER JACK
X : ±0.5	X : ±2'	DWM	Springwu
X.X : ±0.3	X.X : ±1'	CHKD	Sky
X.XX : ±0.2		APVD	Lussen

PART NO.	2DC3189-000111F
SCALE	4:1
UNIT	mm
SIZE	A3
SHEET	1 OF 2
REV	A
CUSTOMER COPY	

REV.	ECN NO OR DESCRIPTION	REVISED	DATE
A	PDR NO. S151106-8A	Springwu	2016.3.28

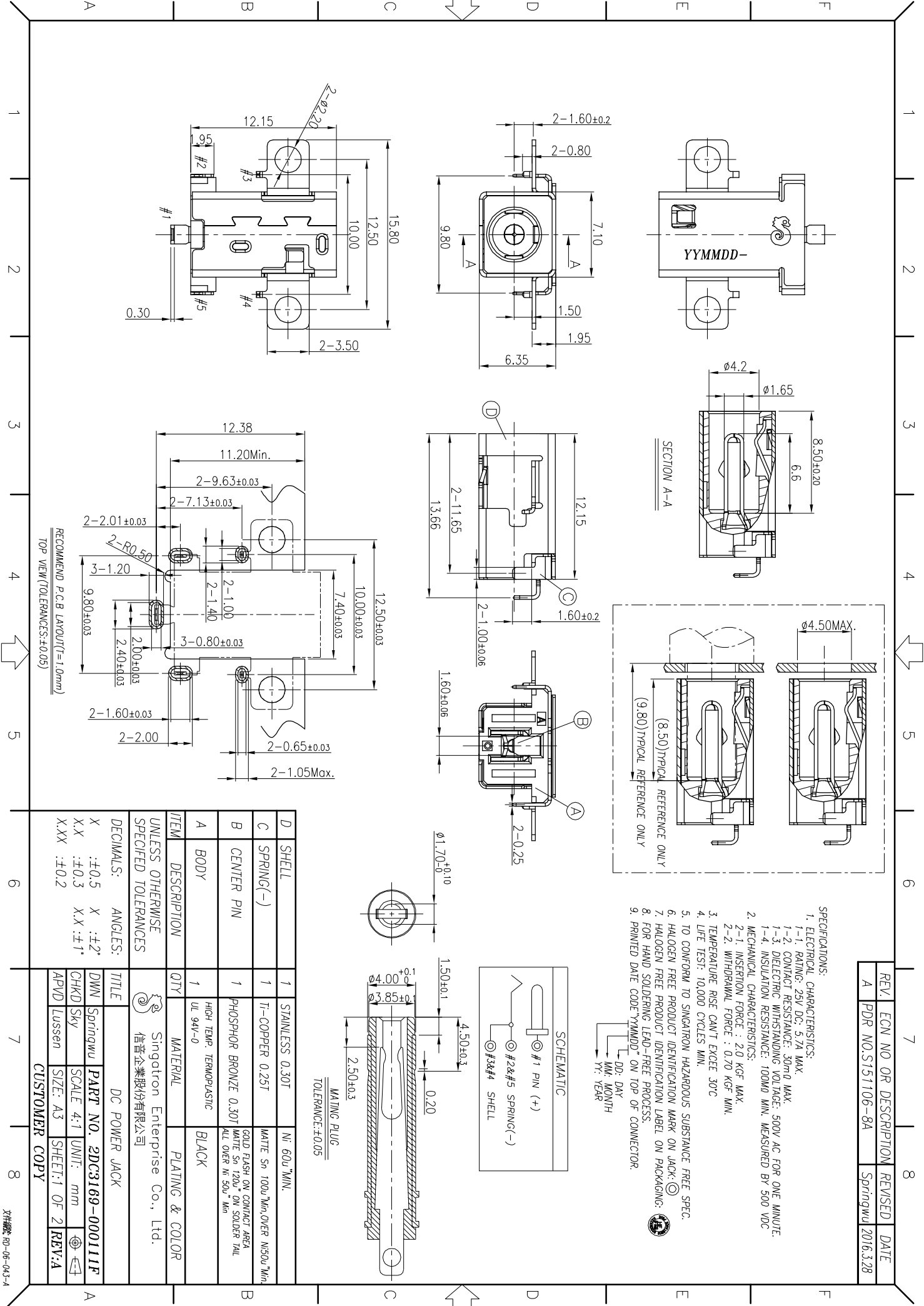

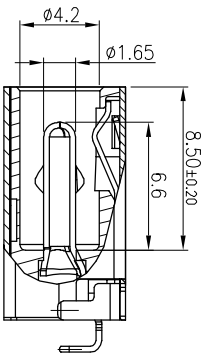

P/N. 2DC3169-000111F

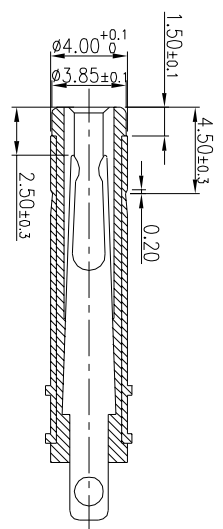
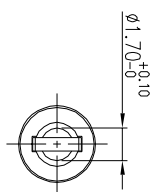

3. LOCK POSITION

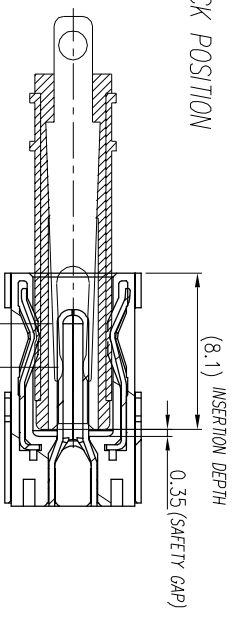

1. NEGATIVE CONTACT FIRST

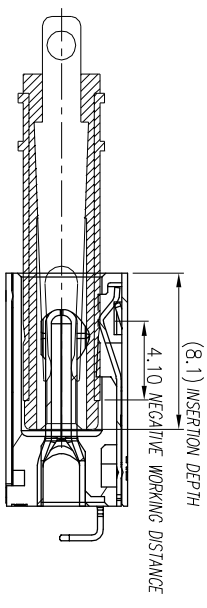

4. FULL INSERTION

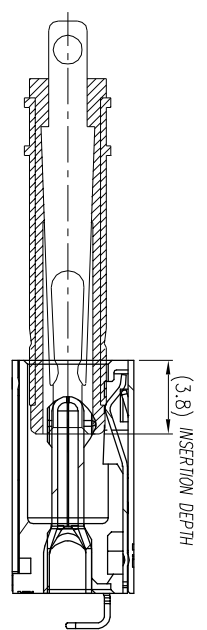

2. POSITIVE CONTACT

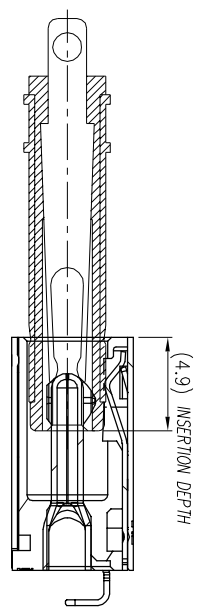
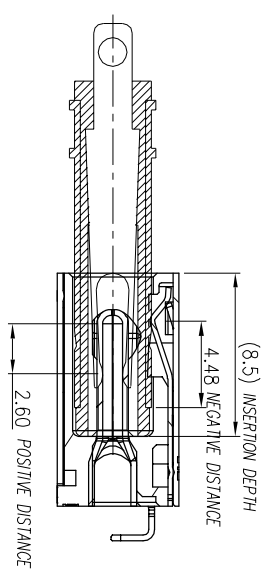

REV.	ECN NO OR PDR NO.	DESCRIPTION	REVISED	DATE
A	S151106-8A	Springwul	2016.3.28	

ITEM	DESCRIPTION	QTY	MATERIAL	PLATING & COLOR
	UNLESS OTHERWISE SPECIFIED TOLERANCES		Singatron Enterprise Co., Ltd. 信晉企業股份有限公司	
	DECIMALS:		DC POWER JACK	
X	:±0.5	X	:±2°	
X.X	:±0.3	X.X	:±1°	
X.XX	:±0.2			
	TITLE			
DWN	Springwul		PART NO. 2DC3169-000111F	
CHKD	Sky		SCALE 4:1	UNIT: mm
APVD	Lussen		SIZE: A3	SHEET: 2 OF 2
			REV: 4	

CUSTOMER COPY