

REV.	ECN NO OR DESCRIPTION	REVISED	DATE
A	PDR NO.:T210623-3A	Springwu	2022.05.30

SPECIFICATIONS:

- ELECTRICAL CHARACTERISTICS:
 - RATING: 20V 17A.
 - CONTACT RESISTANCE: 30mΩ MAX.
 - DIELECTRIC WITHSTANDING VOLTAGE: 500V AC FOR ONE MINUTE.
 - INSULATION RESISTANCE: 100MΩ MIN. MEASURED BY 500V DC.
- MECHANICAL CHARACTERISTICS:
 - INSERTION FORCE : 3.0 Kgf MAX.
 - WITHDRAWAL FORCE : 0.8~3.0Kgf(INITIAL);0.7~3.0kgf(AFTER).
- TEMPERATURE RISE CAN'T EXCEED 30°C.
- LIFE TEST: 5,000 CYCLES MIN.
- OTHER SPEC. REFER TO "2DC3183-003114F SPEC."
- TO CONFORM TO SINGATRON HAZARDOUS SUBSTANCE FREE SPEC.
- HALOGEN FREE PRODUCT IDENTIFICATION MARK ON JACK: ©
- HALOGEN FREE PRODUCT IDENTIFICATION LABEL ON PACKAGING:
- FOR REFLOW SOLDERING LEAD-FREE PROCESS.
- PRINTED DATE CODE "YMMDD" OR "YMD" ON TOP OF JACK.

YY: YEAR DD: DAY
 MM: MONTH MM: MONTH
 DD: DAY YY: YEAR

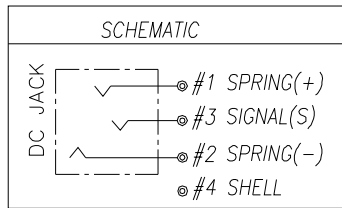
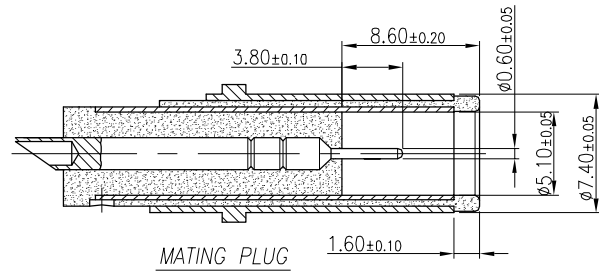
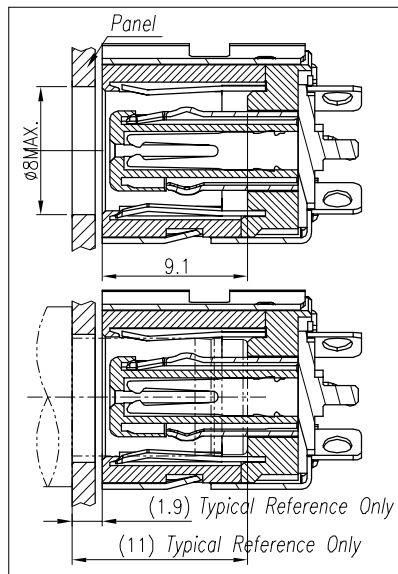

G	SHELL	1	STAINLESS 0.40T	Ni 60u" MIN.
F	SIGNAL	1	COPPER ALLOY 0.30T	GOLD FLASH ON CONTACT AREA; MATTE SN 120u" ON SOLDER TAIL; ALL OVER Ni 50u" Min..
E	SPRING(+)	1	COPPER ALLOY 0.30T	
D	SPRING(-)	1	COPPER ALLOY 0.30T	
C	BACK PLATE	1		BLACK
B	COVER	1	THERMOPLATIC UL 94V-0 (HALOGEN FREE)	BLACK
A	HOUSING	1		BLACK
ITEM	DESCRIPTION	QTY	MATERIAL	PLATING & COLOR
UNLESS OTHERWISE SPECIFIED TOLERANCES			Singatron Enterprise Co., Ltd. 信音企業股份有限公司	
DECIMALS:		TITLE		
X	:±0.5	DWN Springwu PART NO. 2DC3183-003114F		
X.X	:±0.3	CHKD Lussen SCALE: 4:1 UNIT: mm		
X.XX	:±0.2	APVD Liao SIZE: A3 SHEET: 1 OF 2 REV:A		
CUSTOMER COPY				

1

2

3

4

5

6

7

8

REV.	ECN NO OR DESCRIPTION	REVISED	DATE
A	PDR NO.:T210623-3A	Springwu	2022.05.30

1. SPRING(-) CONTACT FIRST

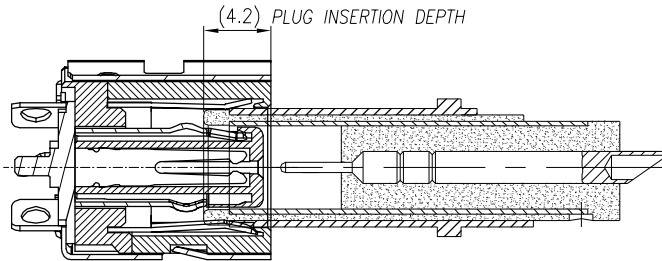

4. FULL INSERTION

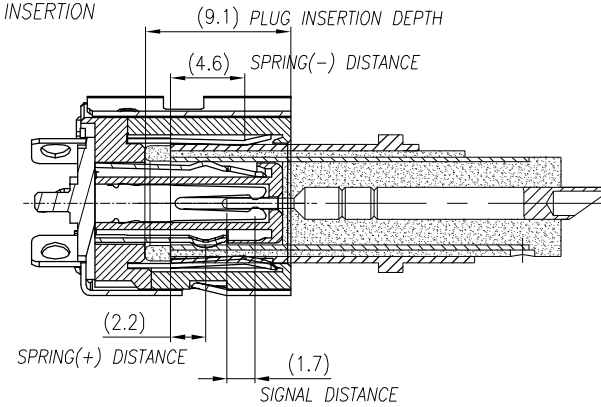

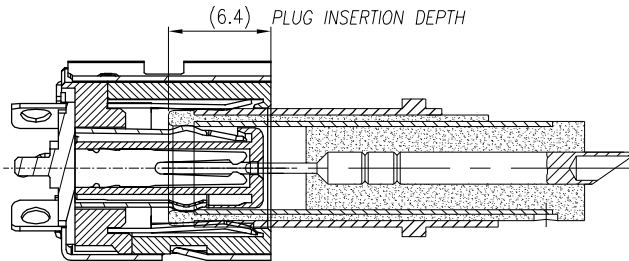

2. SPRING(+) CONTACT SECOND

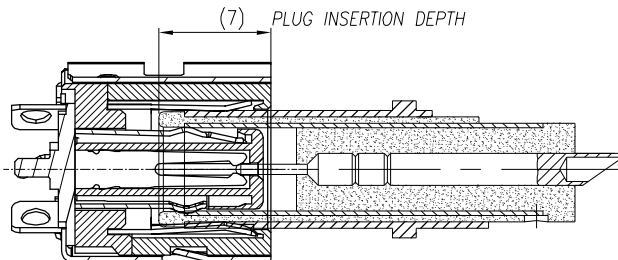

3. SIGNAL CONTACT



ITEM	DESCRIPTION	QTY	MATERIAL	PLATING & COLOR
UNLESS OTHERWISE SPECIFIED TOLERANCES		 Singatron Enterprise Co., Ltd. 信音企業股份有限公司		
DECIMALS: X :±0.5 X.X :±0.3 X.XX :±0.2		ANGLES: X :±2° X.X :±1°		TITLE: ø7.4 DC POWER JACK
DWN	Springwu	PART NO. 2DC3183-003114F		A
CHKD	Lussen	SCALE: 4:1	UNIT: mm	
APVD	Liao	SIZE: A3	SHEET: 2 OF 2	
CUSTOMER COPY				

1

2

3

4

5

6

7

8