

REV.	ECN NO OR DESCRIPTION	REVISED	DATE
A	PDR NO.:T170907-1A	Xuehua	2018.9.30

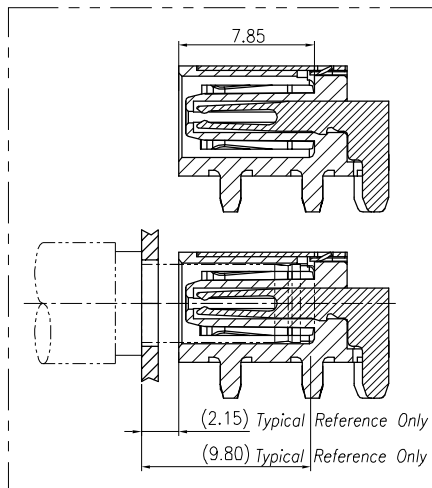

SPECIFICATIONS:

- ELECTRICAL CHARACTERISTICS:
 - RATING: 20V 11.5A
 - CONTACT RESISTANCE: 30mΩ MAX.
 - DIELECTRIC WITHSTANDING VOLTAGE: 500V AC FOR ONE MINUTE.
 - INSULATION RESISTANCE: 100MΩ MIN. MEASURED BY 500 VDC
- MECHANICAL CHARACTERISTICS:
 - INSERTION FORCE: 3.0 Kgf MAX.
 - WITHDRAWAL FORCE: 0.3~3.0Kgf.
- LIFE TEST: 5,000 CYCLES.
- TO CONFORM TO SINGATRON HAZARDOUS SUBSTANCE FREE SPEC.
- HALOGEN FREE PRODUCT IDENTIFICATION MARK ON JACK: (C)
- HALOGEN FREE PRODUCT IDENTIFICATION LABEL ON PACKAGING: (E)
- FOR HAND SOLDERING LEAD-FREE PROCESS.
- PRINTED DATE CODE "YYMMDD".

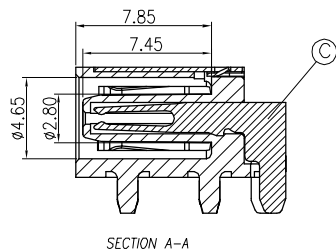
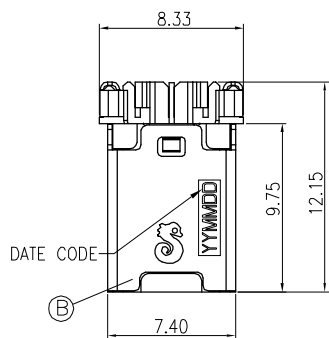
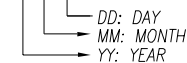

9. THE PANEL'S ID MUST BE GREATER THAN THE PLUG'S OD WHICH MUST HAVE A DIFFERENCE OF LESS THAN OR EQUAL TO 0.5 mm. (AS SHOWN IN FIGURE 1.)

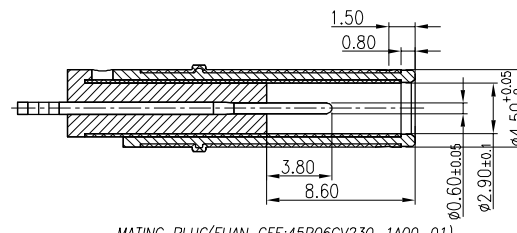
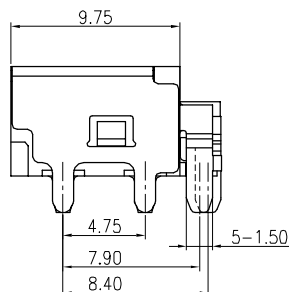
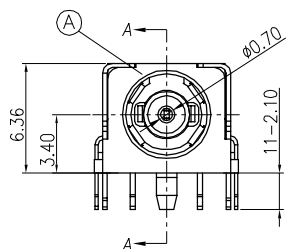

MATING PLUG(FUAN GEE:45P06CV230-1A00-01)
TOLERANCE:X.XX:±0.10

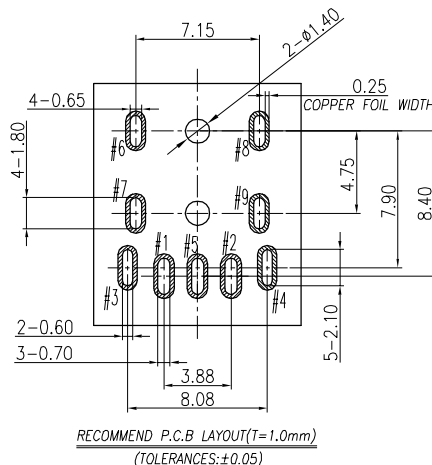
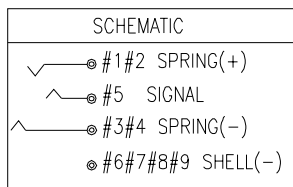
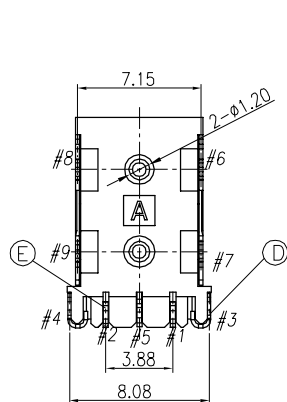
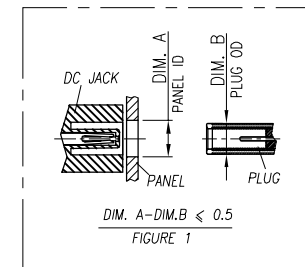

E	SPRING(+)	1	COPPER ALLOY 0.30T	Matte Sn80u"Min On Solder Tail.
D	SPRING(-)	1	COPPER ALLOY 0.20T	All Over Ni 50u"Min.
C	SIGNAL	1	COPPER ALLOY 0.30T	Gold Flash On Contact Area. Matte Sn80u"Min On Solder Tail. All Over Ni 50u"Min.
B	SHELL	1	STAINLESS STEEL 0.25T	Ni 50u"Min.
A	BODY	1	HIGH TEMP.THERMOPLASTIC (HALOGEN FREE)UL 94V-0	BLACK
NO	DESCRIPTION	QTY	MATERIAL	PLATING & COLOR

UNLESS OTHERWISE SPECIFIED TOLERANCES

Singatron Enterprise Co., Ltd.
信音企業股份有限公司

DECIMALS:	ANGLES:	TITLE	DC POWER JACK	
X :±0.5	X :±2°	DWN Xuehua	PART NO. 2DC3191-000111F	
X.X :±0.3	X.X :±1°	CHKD	SCALE 4:1	UNIT: mm
X.XX :±0.2		APVD	SIZE: A3	SHEET: 1 OF 2

CUSTOMER COPY

REV	ECN NO OR DESCRIPTION	REVISED	DATE
A	PDR NO.:T170907-1A	Xuehua	2018.9.30

1. SPRING(-) CONTACT

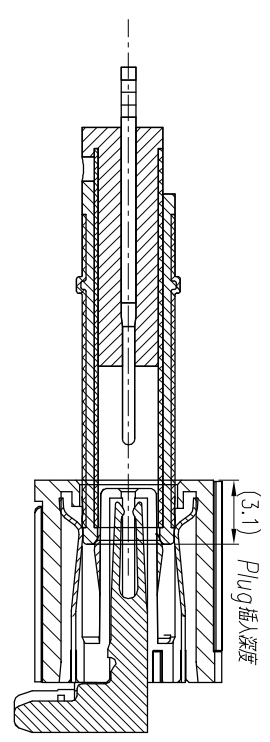

2. PIN(+) CONTACT

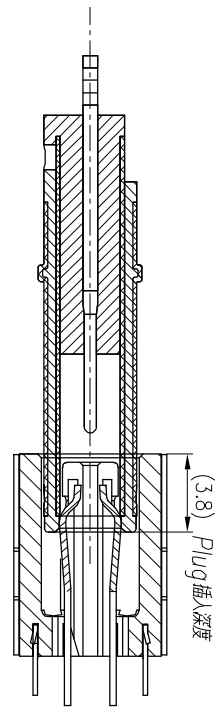

4. Plug Full Mating 狀態

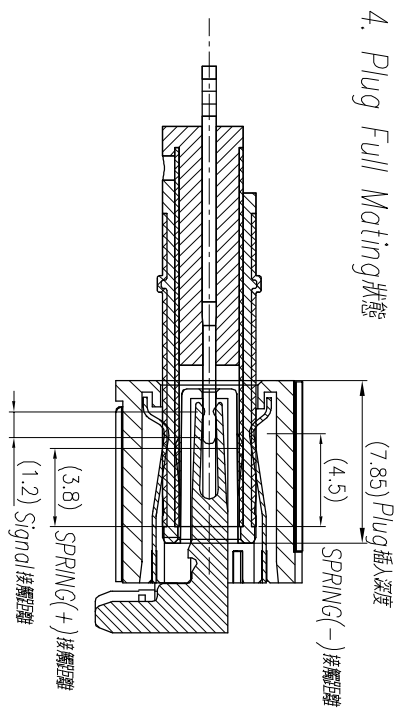

3. SIGNAL PIN CONTACT

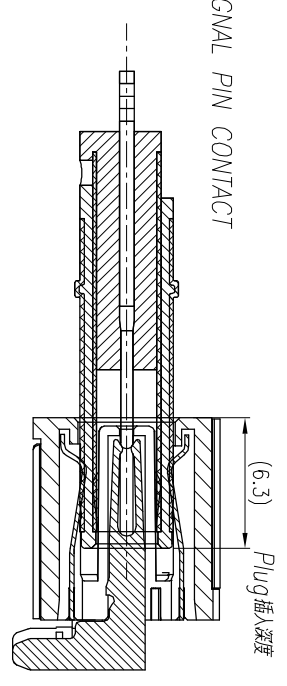

UNLESS OTHERWISE SPECIFIED TOLERANCES		 Singatron Enterprise Co., Ltd. 信音企業股份有限公司	
DECIMALS:	ANGLES:	MATING	
X :±0.5	X :±2°	DWN	Xuehua
X.X :±0.3	X.X :±1°	CHKD	
X.XX :±0.2		APVD	
		PART NO.	2DC3191-000111F
		SCALE	4:1
		UNIT:	mm
		SIZE:	A3
		SHEET:	2 OF 2
		REV:	A
CUSTOMER COPY			

1 2 3 4 5 6 7 8