

REV.	ECN NO OR DESCRIPTION	REVISED	DATE
A	PDR NO: T200817-5A	Springwu	2021.11.26
B	ECN NO: S202211-R06	Springwu	2022.12.09
C	ECN NO: S202312-R09△	Can	2024.2.1

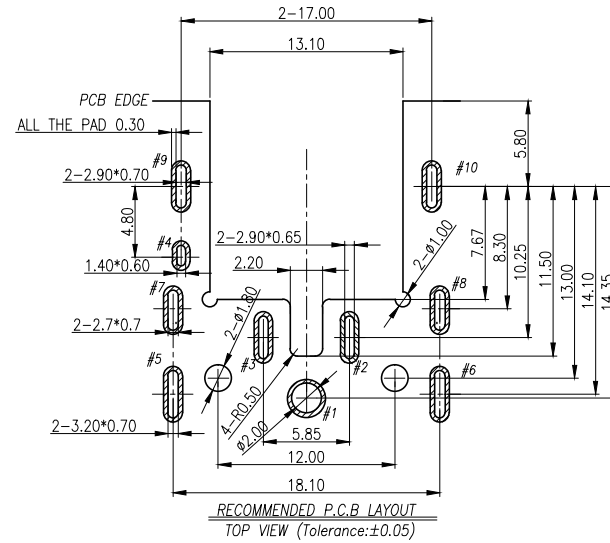

SPECIFICATIONS:

- ELECTRICAL CHARACTERISTICS:
 - 1-1. RATING: DC 20V 20A
 - 1-2. CONTACT RESISTANCE: 10mΩ MAX.(INITIAL)(ONLY FOR PIN+&SPRING-)
CONTACT RESISTANCE: 30mΩ MAX.(INITIAL)(ONLY FOR DETECT)
 - 1-3. DIELECTRIC WITHSTANDING VOLTAGE: 550V AC FOR ONE MINUTE.
 - 1-4. INSULATION RESISTANCE: 100MΩ MIN. MEASURED BY 500 VDC
- MECHANICAL CHARACTERISTICS:
 - 2-1. INSERTION FORCE:0.8~3.0 Kgf (INITIAL&AFTER LIFE TEST)
 - 2-2.WITHDRAWAL FORCE:0.8~3.0 Kgf (INITIAL&AFTER LIFE TEST)
- LIFE TEST: 5,000 CYCELS.
- OTHER GENERAL SPEC. TO REFER "2DC3215-001111F SPEC".
- TO CONFORM TO SINGATRON HAZARDOUS SUBSTANCE FREE SPEC.
- HALOGEN FREE PRODUCT IDENTIFICATION MARK ON JACK: Ⓢ
- HALOGEN FREE PRODUCT IDENTIFICATION LABEL ON PACKAGING: ♻️
- FOR HAND SOLDERING LEAD-FREE PROCESS.

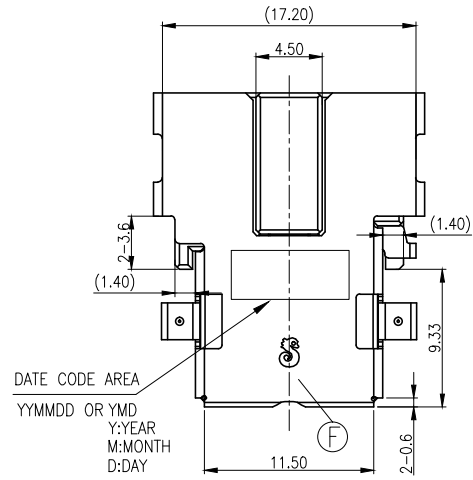
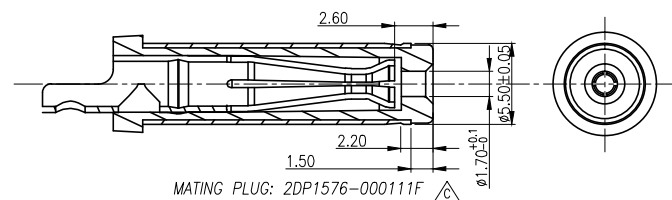
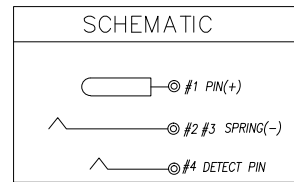
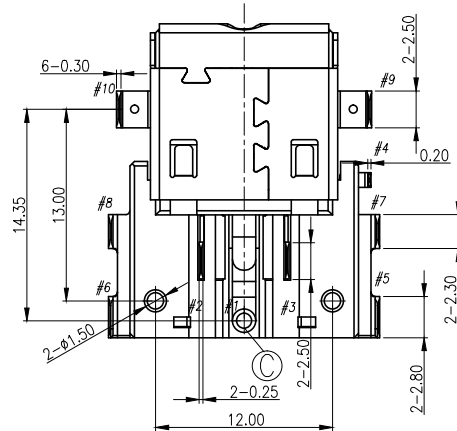
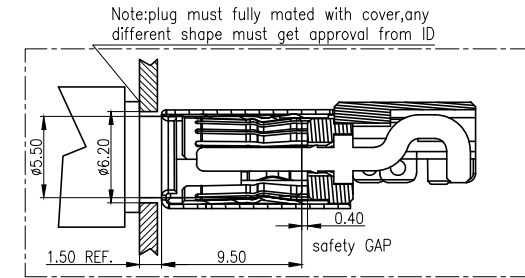
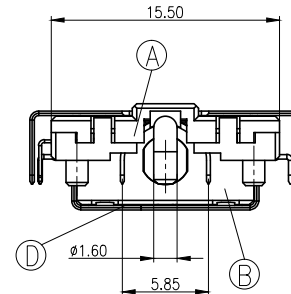
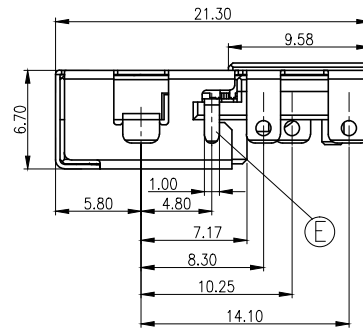
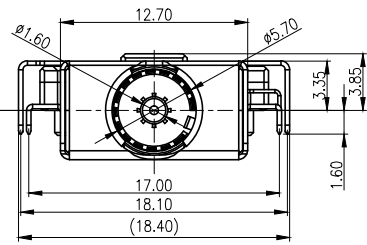

NO	DESCRIPTION	QTY	MATERIAL	PLATING & COLOR
F	SHIELDING	1	STAINLESS 0.3T	Ni 60u"Min.
E	DETECT PIN	1	COPPER ALLOY 0.2T	
D	SPRING(-)	1	COPPER ALLOY 0.25T	GOLD FLASH ALL OVER Ni 60 u" Min.
C	PIN(+)	1	BRASS	
B	BODY BASE	1	HIGH TEMP.THERMOPLASTIC (HALOGEN FREE)UL 94V-0	BLACK
A	BODY TOP	1	(HALOGEN FREE)UL 94V-0	
UNLESS OTHERWISE SPECIFIED TOLERANCES		Singatron Enterprise Co., Ltd. 信音企業股份有限公司		
DECIMALS: ANGLES:		TITLE DC POWER JACK		
X	:±0.5	X	:±2°	DWN Can PART NO. 2DC3215-001111F
X.X	:±0.3	X.X	:±1°	CHKD SCALE 4:1 UNIT: mm
X.XX	:±0.2			APVD SIZE: A3 SHEET:1 OF 2 REV:C
CUSTOMER COPY				

REV.	ECN NO OR DESCRIPTION	REVISED	DATE
A	PDR NO: T200817-5A	Springwu	2021.11.26
B	ECN NO: S202211-R06	Springwu	2022.12.09
C	ECN NO: S202312-R09 \triangle	Can	2024.2.1

1. NEGATIVE CONTACT

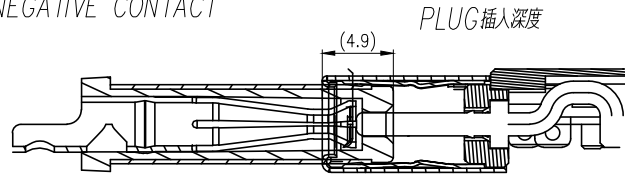

2. POWER PIN(+) CONTACT

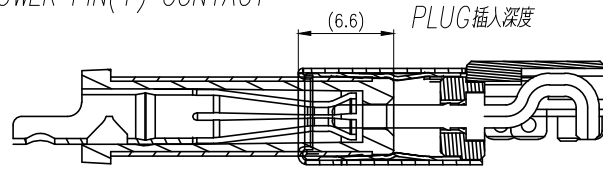

3. DETECT PIN CONTACT

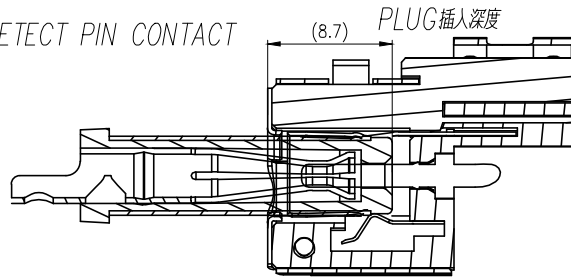

4. LOCKED

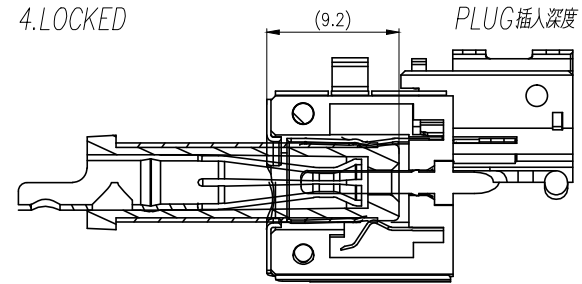

5. FULL MATING

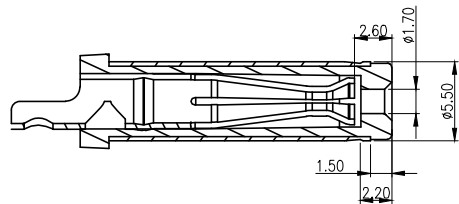
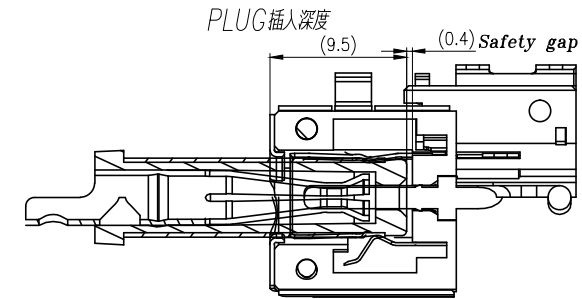

MATING PLUG: 2DP1576-000111F \triangle

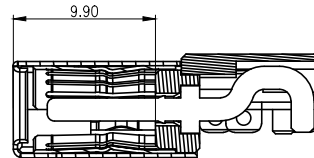

NO	DESCRIPTION	QTY	MATERIAL	PLATING & COLOR
UNLESS OTHERWISE SPECIFIED TOLERANCES		Singatron Enterprise Co., Ltd. 信音企業股份有限公司		
DECIMALS:	ANGLES:	TITLE	MATING DRAWING	
X : ±0.5	X : ±2°	DWN	Can	PART NO. 2DC3215-001111F
X.X : ±0.3	X.X : ±1°	CHKD	SCALE 4:1	UNIT: mm
X.XX : ±0.2		APVD	SIZE: A3	SHEET: 2 OF 2 REV: C
CUSTOMER COPY				