

REV.	ECN NO OR DESCRIPTION	REVISED	DATE
A	PDR NO: T220408-2A	JIE-FU	2023.04.07

SPECIFICATIONS:

- ELECTRICAL CHARACTERISTICS:**
 - RATING: DC 20V 17A.
 - CONTACT RESISTANCE: 30mΩ MAX.
 - DIELECTRIC WITHSTANDING VOLTAGE: 550V AC FOR ONE MINUTE.
 - INSULATION RESISTANCE: 100MΩ MIN. MEASURED BY 500 VDC
- MECHANICAL CHARACTERISTICS:**
 - INSERTION FORCE: 0.8~2.5 Kgf
 - WITHDRAWAL FORCE: 0.8~2.5 Kgf
- LIFE TEST: 8,000 CYCLES.**
- OTHER GENERAL SPEC. TO REFER "2DC3224-000111F SPEC".**
- TO CONFORM TO SINGATRON HAZARDOUS SUBSTANCE FREE SPEC.**
- HALOGEN FREE PRODUCT IDENTIFICATION MARK ON JACK: Ⓢ**
- HALOGEN FREE PRODUCT IDENTIFICATION LABEL ON PACKAGING: Ⓢ**
- FOR IR REFLOW SOLDERING LEAD-FREE PROCESS.**

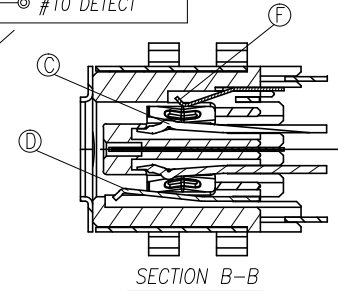
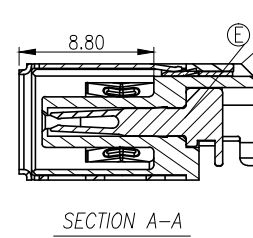
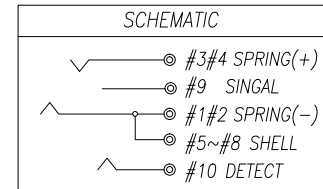

RECOMMENDED P.C.B LAYOUT TOP VIEW
TOLERANCE:±0.05 THICKNESS=0.8~1.2T

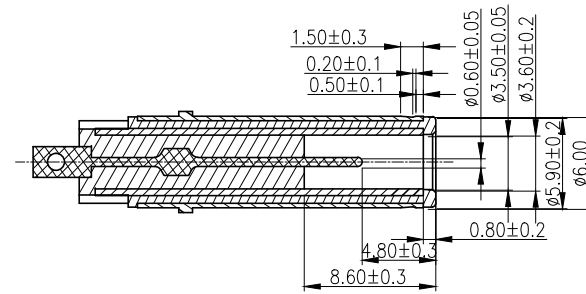
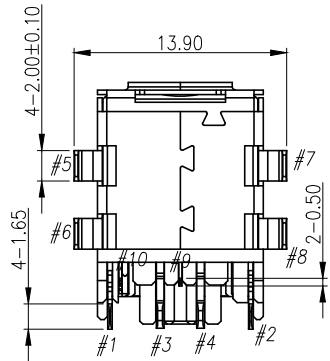
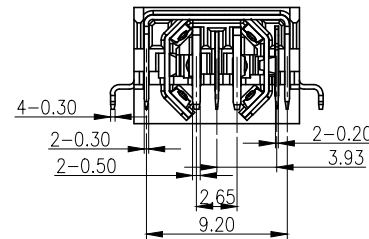
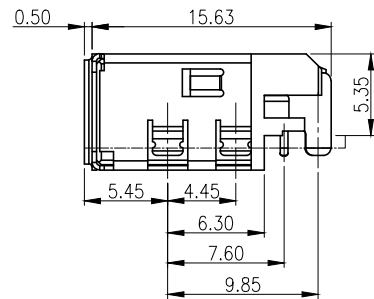
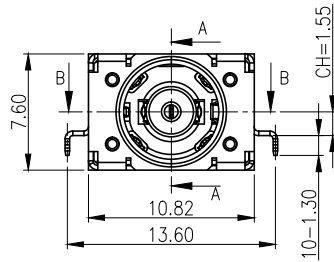
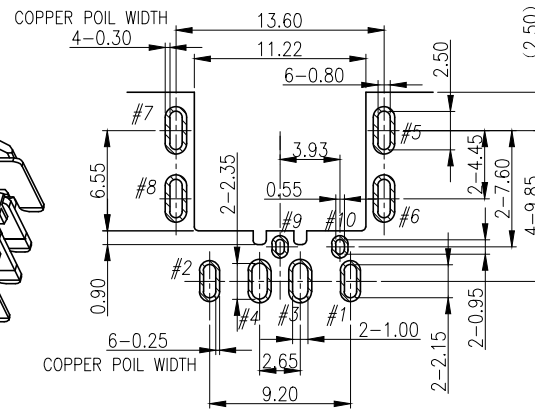

F	DETECT	1	C5210-EH 0.2T	Au 1u" Min.ON CONTACT AREA; MATTE Sn 120u" ON SOLDER TAIL ALL OVER Ni 50u" MIN..
E	SINGAL	1	C5210-EH 0.2T	
D	SPRING(-)	1	C7035-TM04 0.3T	
C	SPRING(+)	2	C18150-R540 0.5T	
B	SHELL	1	SUS304-1/2H 0.3T	
B	SHELL	1	SUS304-1/2H 0.3T	Ni 60u" Min..
A	BODY	1	PA10T+30%GF UL94V-0	BLACK
NO	DESCRIPTION	QTY	MATERIAL	PLATING & COLOR

UNLESS OTHERWISE SPECIFIED TOLERANCES		Singatron Enterprise Co., Ltd. 信音企業股份有限公司	
DECIMALS:	ANGLES:	TITLE	
X :±0.5	X :±2°	DC POWER JACK	
X.X :±0.3	X.X :±1°	DWN	JIE-FU PART NO. 2DC3224-000111F
X.XX :±0.2		CHKD	LUSSEN SCALE 4:1 UNIT: mm
		APVD	LIAO SIZE: A3 SHEET:1 OF 2 REV:A
CUSTOMER COPY			

REV.	ECN NO OR DESCRIPTION	REVISED	DATE
A	PDR NO: T220408-2A	JIE-FU	2023.04.07

1. SPRING- CONTACT STATUS

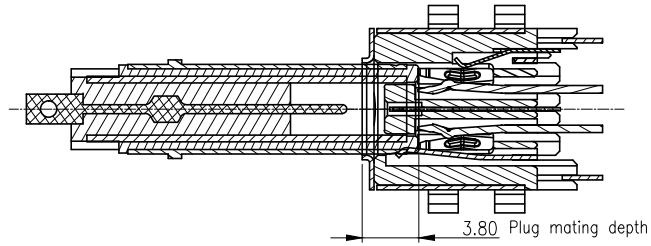

2. SPRING+ CONTACT STATUS

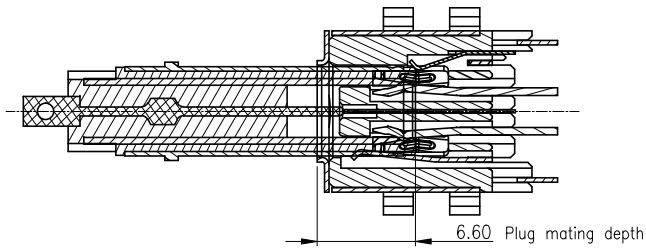

3. SINGAL CONTACT STATUS

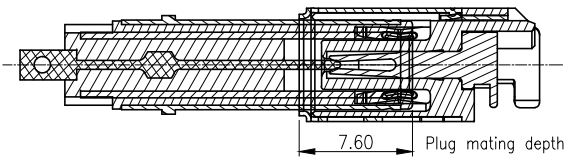

4. LOCKED STATUS

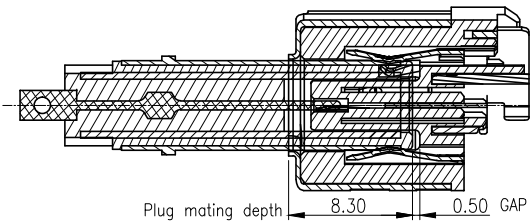

Spring- pin contact travel 4.50
0.50 Detect pin contact travel

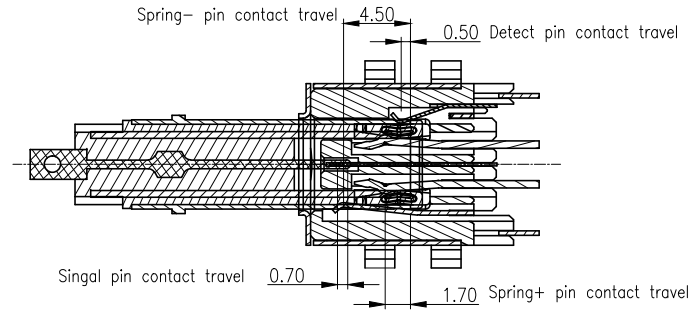

5. FULLY MATED

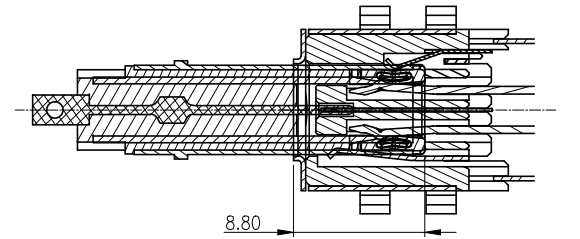

Note: plug must fully mated with cover, any different shape must get approval from ID

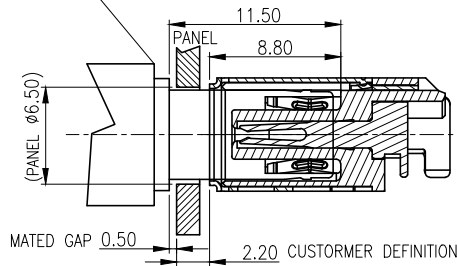

NO	DESCRIPTION	QTY	MATERIAL	PLATING & COLOR
UNLESS OTHERWISE SPECIFIED TOLERANCES		 Singatron Enterprise Co., Ltd. 信音企業股份有限公司		
DECIMALS:	ANGLES:	TITLE	MATING DRAWING	
X :±0.5	X :±2°	DWN	JIE-FU	PART NO. 2DC3224-000111F
X.X :±0.3	X.X :±1°	CHKD	LUSSEN	SCALE 4:1 UNIT: mm
X.XX :±0.2		APVD	LIAO	SIZE: A3 SHEET:2 OF 2 REV:A
CUSTOMER COPY				