

REV.	ECN NO.	OR DESCRIPTION	REVISED	DATE
A	PDR NO.:	S120529-15B	Shown	2013.01.18

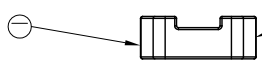
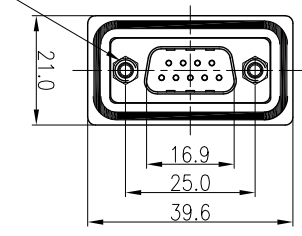
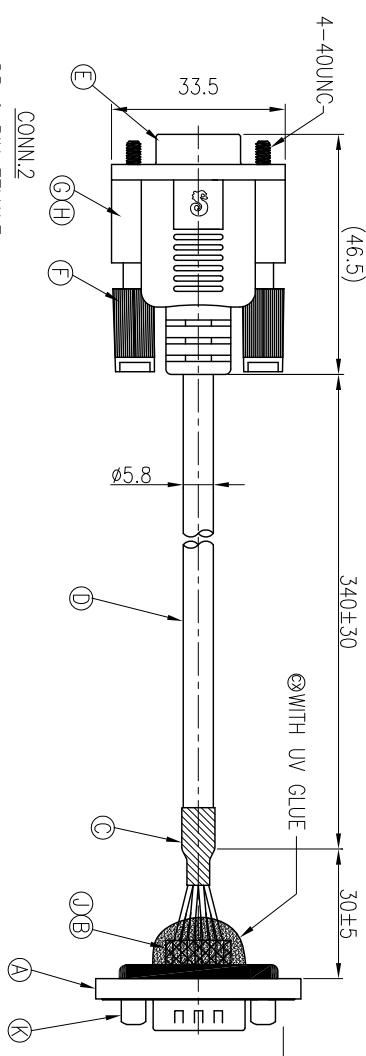
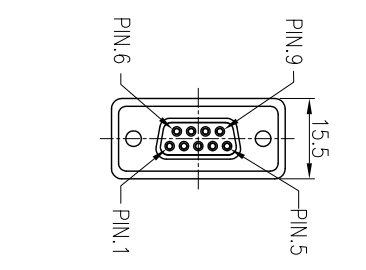

DB 9 PIN FEMALE
NON-WATERPROOF

CONN.2

DB 9 PIN MALE
WATERPROOF RATE: IP67

CONN.1

INCIDENTAL SHIPMENT, NO NEED ASSEMBLY

⊗MUST BE SCREWED IN DB9 CONN FOR 2PCS L=6mm SCREWS

⊗WITH UV GLUE

9	BLACK	9
8	RED	8
7	PINK	7
6	GRAY	6
5	YELLOW	5
4	GREEN	4
3	WHITE	3
2	BLUE	2
1	BROWN	1
CONN1	WIRE COLOR	CONN2
PIN OUT		

- NOTES:
1. WATERPROOF RATE: IP67
 2. RATING: 5A
 3. OTHER GENERAL SPEC. TO REFER "D-SUB SERIES SPEC."
 4. TO CONFORM TO SINGATRON HAZARDOUS SUBSTANCE FREE SPEC.
 5. GREEN PRODUCT IDENTIFICATION LABEL ON PACKAGING: **G.P. PASS**

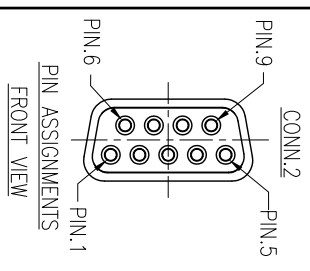
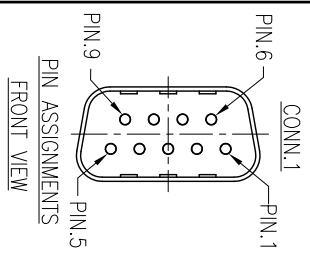
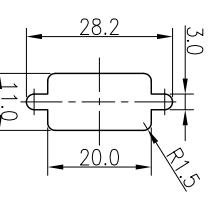
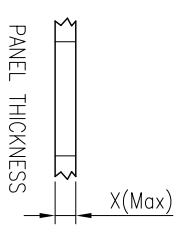

SCREW L=6.0 FOR PANEL THICKNESS BETWEEN 1.2~2.0mm

K	SCREW	4	BRASS	NI PLATING 50~80u"
J	UV GLUE	1	N/A	NATURAL
I	DUST CAP	1	N/A	NATURAL
H	INNER MOLD	1	LD-PE	NATURAL
G	OVER MOLD	1	PVC(45P)	BLACK
F	SCREW	2	4#-40 NICKEL PLATED	N/A
E	CONNECTOR	1	DB 9 PIN FEMALE	TIN PLATED
D	CABLE	1	UL2464 24AWG*9C+AL UV RESISTANT OD=φ5.8	BLACK(PVC JACKET)
C	SHRINK TUBE	1	φ6.0*15	BLACK
B	SHRINK TUBE	9	φ2.0*10	BLACK
A	MALE CONN	1	P/N:2DS3012-W09300H	N/A
NO	DESCRIPTION	QTY	MATERIAL	PLATING & COLOR

UNLESS OTHERWISE SPECIFIED TOLERANCES

Singatron Enterprise Co., Ltd.
信亨企業股份有限公司

DECIMALS:	ANGLES:	TITLE	D-SUB 9 PIN CONN	SOLDER TYPE
X :.f0.5	X :±2°	DWN	Shown	PART NO.2DS3012-W09300H
X.X :.f0.3	X.X :±1°	CHKD	Harlen	SCALE 1:1
X.XX :.f0.2		APVD	Steve	SIZE: A3 SHEET: 1 OF 1

CUSTOMER COPY