

REV.	ECN NO OR DESCRIPTION	REVISED	DATE
A	PDR NO:T160604-1A	Springwu	2016.08.30
B	ECN NO:S181114-C	Jie	2018.11.06

SPECIFICATIONS:

- DC POWER JACK AND WIRE SPEC:
  - 1-1.RATING:20V/12A;
  - 1-2.CONTACT RESISTANCE:30mΩ MAX.(INITIAL)(ONLY FOR DC JACK);
  - 1-3.CONTACT RESISTANCE:20mΩ MAX.(INITIAL)(ONLY FOR HOUSING);
  - 1-4.CONTACT RESISTANCE:10mΩ MAX.(INITIAL)(ONLY FOR CABLE);
  - 1-5.DIELECTRIC WITHSTANING VOLTAGE:500V AC FOR ONE MINUTR.
  - 1-6.INSULATION RESISTANCE:100MΩ MIN. MEASURED BY 500V DC.
- MECHANICAL CHARACTERISTICS:
  - 2-1. INSERTION FORCE : 3.0 KGF Max.
  - 2-2. WITHDRAWAL FORCE : 0.40 KGF Min.
- LIFE TEST: 5,000 CYCLES MIN.
- OTHER GENERAL SPEC. TO REFER "2DW2018-039111F SPEC".
- TO CONFORM TO SINGATRON HAZARDOUS SUBSTANCE FREE SPEC.
- HALOGEN FREE PRODUCT IDENTIFICATION MARK ON JACK:
- HALOGEN FREE PRODUCT IDENTIFICATION LABEL ON PACKAGING:
- FOR HAND SOLDERING LEAD-FREE PROCESS.
- FOR ECHO 15/180W.
- THE PANEL'S ID MUST BE GREATER THAN THE PLUG'S OD WHICH MUST HAVE A DIFFERENCE OF LESS THAN OR EQUAL TO 0.5 mm.(AS SHOWN IN FIGURE 1.)

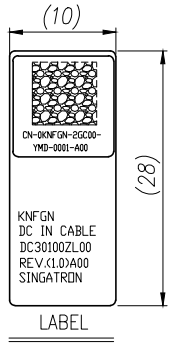
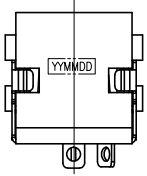
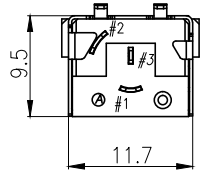
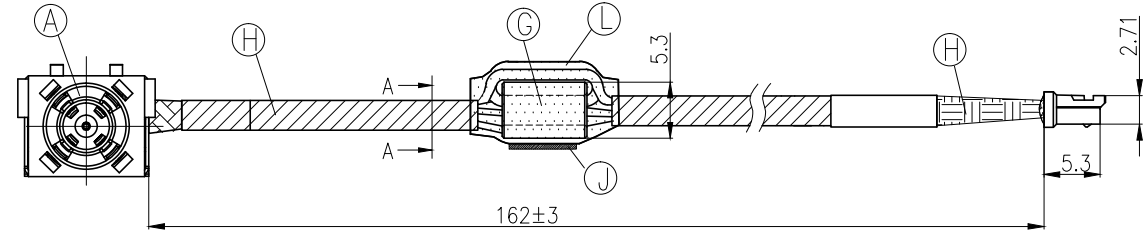
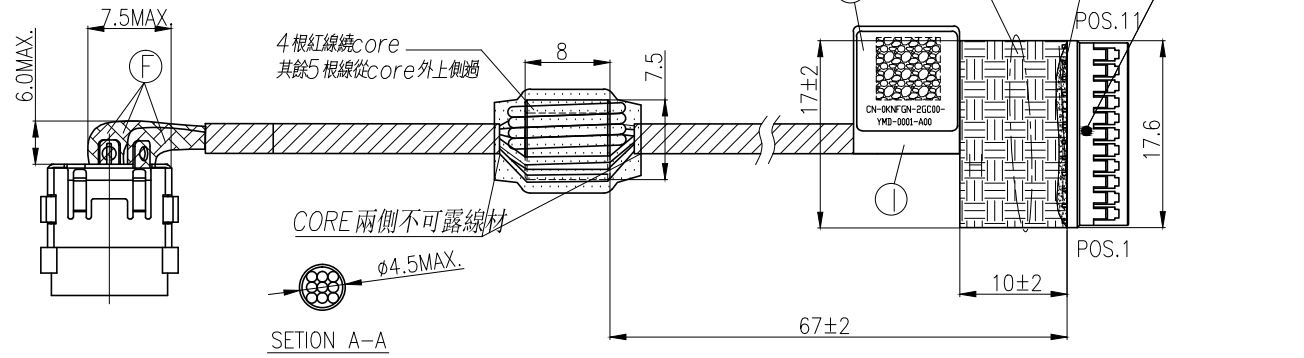

ITEMS	DC JACK	HOUSING	CABLE
RATING VOLTAGE (V)	20V	50V	20V
RATING CURRENT (A)	13A	3A Per Pin	12A
OPERATION TEMPERATURE(°C) RANGE(°C)	-10 ~ 85	-25 ~ 85	105
插入力 (KG)	3.0 MAX.		
拔出力 (KG)	0.4 MIN.		

WIRE DIAGRAM		
CONNECTOR	WIRE COLOR	DC POWER JACK
POS.1		N/A
POS.2	RED (26AWG)	SPRING (+) (#1)
POS.3	RED (26AWG)	
POS.4	RED (26AWG)	
POS.5	RED (26AWG)	
POS.6	BLACK (26AWG)	SPRING (-) (#2)
POS.7	BLACK (26AWG)	
POS.8	BLAVK (26AWG)	
POS.9	BLAVK (26AWG)	
POS.10	BLUE (26AWG)	SIGNAL (S) (#3)
POS.11		N/A

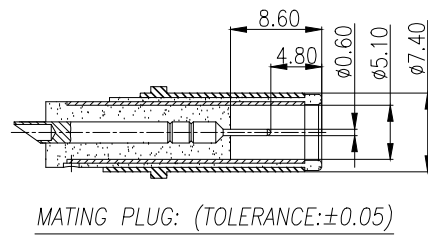
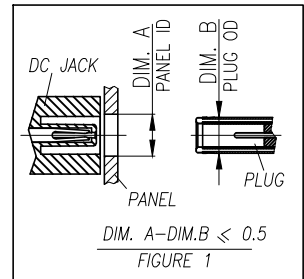

L	HEAT SHRINK TUBE	1	FOLYOLIFEN φ10(125' 300V)	BLACK
K	PPID LABEL	1	9.5*9.5	WHITE
J	ADHESIVE TAPE	1	5*6	WHITE
I	LABEL	1	L28*W10	WHITE
H	ACETATE FABRIC	3	0.12T	BLACK
G	CORE	1	Mode: NiMoZn-600 Size: 7.5*5.3*8 Manufacturer: SINCORES ELECTRONICS(D.G)CORP	BLACK
F	HEAT SHRINK TUBE	3	POLYOLEFIN φ4&φ2.5(125' 300V)	BLACK
E	WIRE	1	UL10368 26AWG	BLUE
D	WIRE	4	UL10368 26AWG	BLACK
C	WIRE	4	UL10368 26AWG	RED
B	CONNECTOR (TYU_TU1502 SERIES)	9	TER:COPPER ALLOY	GOLD FLASH
		1	HSG:THERMOPLASTIC UL94V-0	WHITE
A	DC JACK	1	SINGATRON DC JACK P/N:2DC2018-006111F	
NO	DESCRIPTION	QTY	MATERIAL	PLATING & COLOR
UNLESS OTHERWISE SPECIFIED TOLERANCES			Singatron Enterprise Co., Ltd. 信音企業股份有限公司	
DECIMALS:		TITLE DC JACK WITH WIRE		
X	:±0.5	X	:±2'	DWN Jie PART NO.2DW2018-039111F
X.X	:±0.3	X.X	:±1'	CHKD SCALE:-- UNIT: mm
X.XX	:±0.2			APVD SIZE: A3 SHEET:1 OF 1 REV:B
<b>CUSTOMER COPY</b>				