

| | | | |
|------|-----------------------|---------|-----------|
| REV. | ECN NO OR DESCRIPTION | REVISED | DATE |
| A | PDR NO.:T220829-2A | Jie | 2023.8.21 |

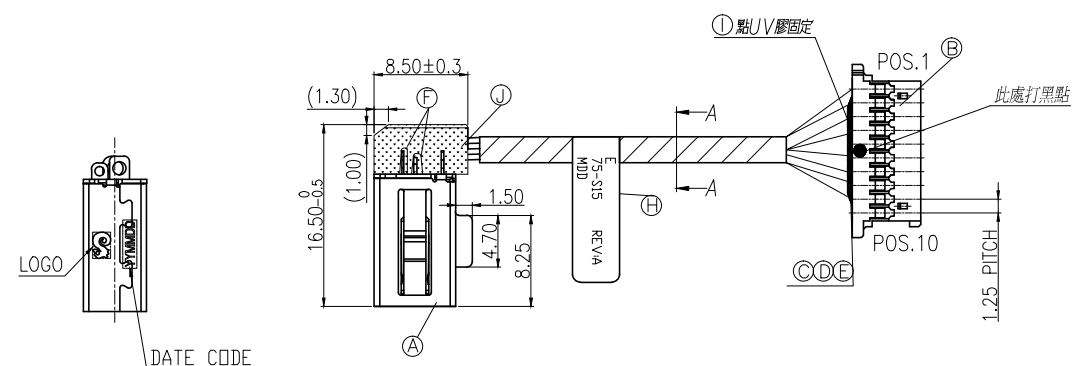

| WIRE DIAGRAM | | |
|---------------|------------|---------------|
| DC POWER JACK | WIRE COLOR | CONNECTOR |
| SPRING(+) | RED | POS.(1,2,3,4) |
| SPRING(-) | BLACK | POS.(5,6,7,8) |
| SIGNAL (S) | WHITE | POS.(9) |
| NC | N/A | POS.(10) |

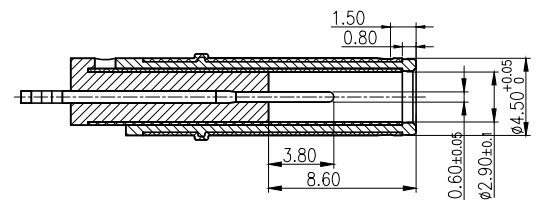
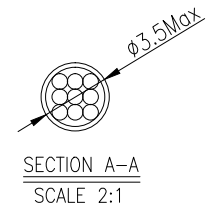
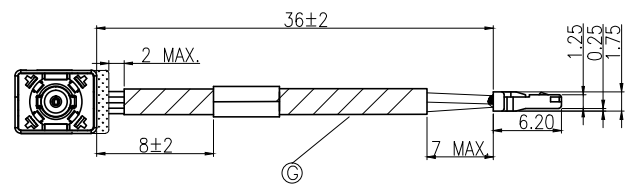

MATING PLUG(FUAN GEE:45P06CV230-1A00-01)
TOLERANCE:X,XX:±0.10

MATES WITH:51483 SERIES WAFER.

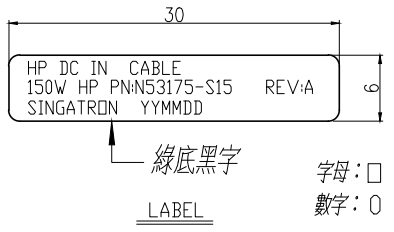
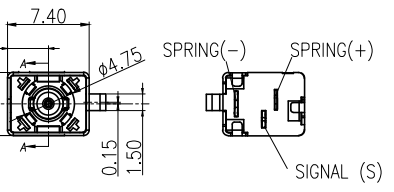

字母: □
數字: 0

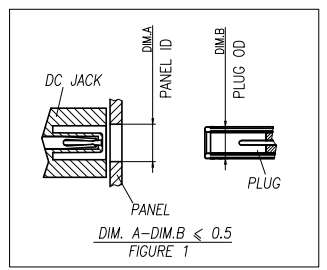
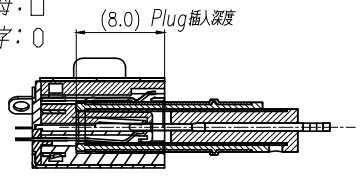

SPECIFICATIONS:

- ELECTRICAL CHARACTERISTICS:
 - RATING:20V 7.5A.
 - CONTACT RESISTANCE:30mΩ MAX.(INITIAL) (ONLY FOR DC JACK)
 - DIELECTRIC WITHSTANDING VOLTAGE:500V AC FOR ONE MINUTE.
 - INSULATION RESISTANCE:100MΩ MIN. MEASURED BY 500V DC.
- MECHANICAL CHARACTERISTICS:
 - INSERTION FORCE:2.5KGF MAX.
 - WITHDRAWAL FORCE:INITIAL 0.8Kgf MIN.;AFTER LIFE TEST:0.6Kgf MIN.
- LIFE TEST:5,000 CYCLES MIN.
- OTHER GENERAL SPEC. TO REFER "2DW3069-088114F SPEC".
- TO CONFORM TO SINGATRON HAZARDOUS SUBSTANCE FREE SPEC.
- HALOGEN FREE PRODUCT IDENTIFICATION MARK ON JACK:
- HALOGEN FREE PRODUCT IDENTIFICATION LABEL ON PACKAGING:
- THE PANEL'S ID MUST BE GREATER THAN THE PLUG'S OD WHICH MUST HAVE A DIFFERENCE OF LESS THAN OR EQUAL TO 0.5 mm.(AS SHOWN IN FIGURE 1.)

| | | | | |
|----|---------------------------------------|-----|--|-----------------|
| J | MACROMELT | / | MACROMELT 6208 | AMBER |
| I | UV膠 | 1 | 8860 匯建電子 | WHITE |
| H | LABEL | 1 | L30*W6 | GREEN |
| G | ACETATE CLOTH TAPE | 1 | T0.12 | BLACK |
| F | HEAT SHRINK TUBE | 2 | FOLYOLIFEN (125',300V) | BLACK |
| E | WIRE | 1 | UL10064 26AWG | WHITE |
| D | WIRE | 4 | UL10064 26AWG | BLACK |
| C | WIRE | 4 | UL10064 26AWG | RED |
| B | CONNECTOR (ACES:51484-010H0H0-001) | 9 | TER:COPPER ALLOY | GOLD-FLASH |
| A | DC POWER JACK | 1 | TO SEE SINGATRON DC JACK P/N:2DC3069-027114F | WHITE |
| NO | DESCRIPTION | QTY | MATERIAL | PLATING & COLOR |

UNLESS OTHERWISE SPECIFIED TOLERANCES

Singatron Enterprise Co., Ltd.
信音企業股份有限公司

| DECIMALS: | ANGLES: | TITLE | DC POWER JACK + WIRE | | |
|---------------|------------|-------|----------------------|--------------------------|--------------|
| X :±0.4 | X :±1° | DWN | Jie | PART NO. 2DW3069-088114F | |
| X.X :±0.3 | X.X :±0.5° | CHKD | Spring | SCALE:-- | UNIT: mm |
| X.XX :±0.2 | | APVD | Liao | SIZE: A3 | SHEET:1 OF 1 |
| CUSTOMER COPY | | | | | |
| REV: A | | | | | |