

REV	ECN NO OR DESCRIPTION	REVISED	DATE
A	PDR NO.: 1230407-3A	XIAO	2024.01.19

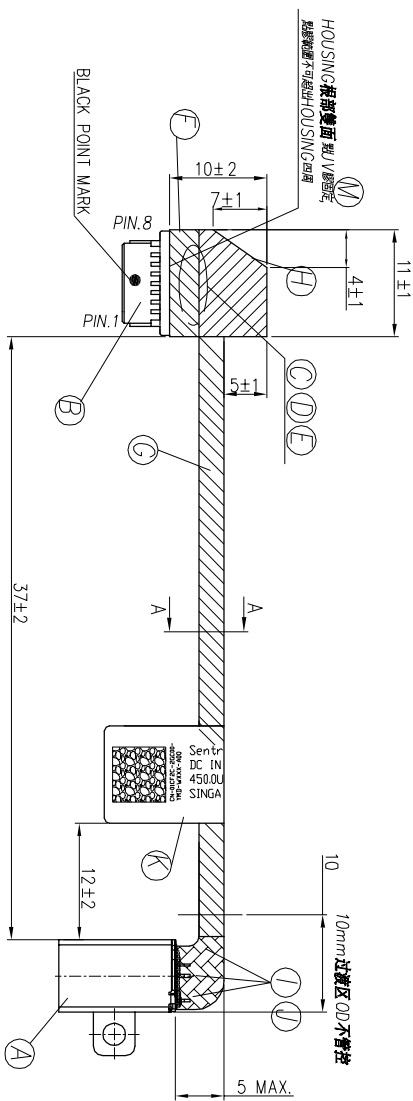

DC JACK:  
2DC3069-036114F(借音)  
P1A111-05KH1X0(真康)

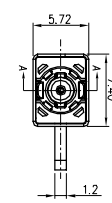
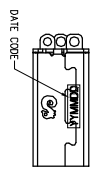
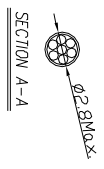

WIRING DIAGRAM		
CONNECTOR	CABLE TYPE/AWG#	COLOR
PIN.1	UL10064 26AWG	WHITE
PIN.2	UL10064 28AWG	BLACK
PIN.3	UL10064 28AWG	BLACK
PIN.4	UL10064 28AWG	BLACK
PIN.5	NA	NA
PIN.6	UL10064 28AWG	NA
PIN.7	UL10064 28AWG	RED
PIN.8	UL10064 28AWG	RED

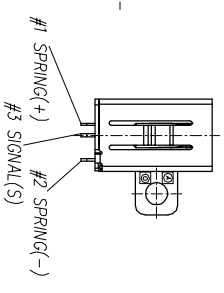
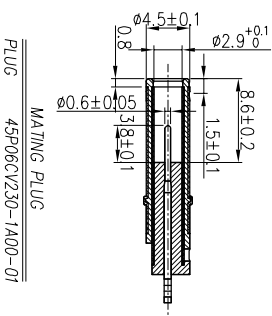

PLUG  
45F06GVZ30-1A00-01

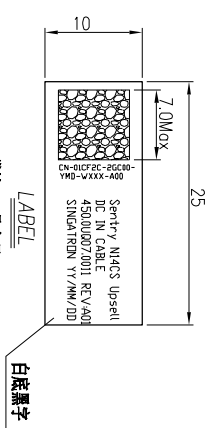

SPECIFICATIONS:

1. ELECTRICAL CHARACTERISTICS:
- 1-1. RATING: 20V 4A
  - 1-2. CONTACT RESISTANCE:  $30\text{m}\Omega\text{MAX}$  (ONLY FOR DC JACK)
  - 1-3. DIELECTRIC WITHSTANDING VOLTAGE: 500V AC FOR ONE MINUTE.
  - 1-4. INSULATION RESISTANCE:  $100\Omega/\text{MIN}$ . MEASURED BY 500V DC.
2. MECHANICAL CHARACTERISTICS:
- 2-1. INSERTION FORCE: 2.0 Kgf MAX.
  - 2-2. INITIAL:  $0.7\sim 2.0$  Kgf;  $0.5\sim 2.0$  Kgf (After Test)
  - 2-3. LIFE TEST: 15,000 CYCLES
  - 2-4. CONTACT RESISTANCE:  $1\Omega$  MAX.
3. OTHER GENERAL SPEC. REFER TO "ZDM3069-08114F" SPEC.
4. TO CONFORM TO SINGATRON HAZARDOUS SUBSTANCE FREE SPEC.
5. HALOGEN FREE PRODUCT IDENTIFICATION MARK ON JACK:
6. HALOGEN FREE PRODUCT IDENTIFICATION LOGO ON PACKAGING:
7. PRINTED DATE CODE "YYMMDD" OR "YMD" ON TOP OF JACK.



M	UV GLUE	1	UV GLUE	WHITE
K	LABEL	1	L25*W10	WHITE
J	HEAT SHRINK TUBE	1	$\phi 2.0(1.25, 3.00V)$	BLACK
I	HEAT SHRINK TUBE	2	$\phi 2.5(1.25, 3.00V)$	BLACK
H	ACETATE TAPE	1	T0.12	BLACK
G	ACETATE TAPE	1	T0.12	BLACK
F	ACETATE TAPE	2	冲切模和0.12T	BLACK
E	WIRE	1	UL10064 26AWG VW-1	WHITE
D	WIRE	3	UL10064 28AWG VW-1	BLACK
C	WIRE	3	UL10064 28AWG VW-1	RED
B	CONNECTOR-WELL LIN	7	WELL LIN 1010-G-P	GOLD FLASH
	CONNECTOR-AGCS	1	WELL LIN 1010-H-08P-HF	WHITE
A	DC POWER JACK	1	E-COMM DC POWER JACK P/N: P1A111-05KH1X0	WHITE
		1	SINGATRON DC POWER JACK P/N: 2DC3069-036114F	WHITE
		1	ACES 50233-008H010-001	WHITE

Singatron Enterprise Co., Ltd.  
信音企業股份有限公司

UNLESS OTHERWISE SPECIFIED TOLERANCES		DECIMALS:		ANGLES:	
X	: ±0.5	X	: ±2°		
X.X	: ±0.3	X.X	: ±1°		
X.XX	: ±0.2				

TITLE	DC POWER JACK WITH WIRE HARNESS
DWM	XIAO PART NO. ZDM3069-096114F
CHKD	ALLEN SCALE: --- UNIT: mm
APVD	BOYE SIZE: A3 SHEET: 1 OF 1 REV: A

CUSTOMER COPY