

REV.	ECN NO OR DESCRIPTION	REVISED	DATE
A	PDR No. T220706-2A	Kesheng	2023.06.19
B	ECN No. S202307-C18	Kesheng	2023.08.04
C	ECN No. S202308-C19	Yizhou	2023.10.11
D	ECN No. S202307-C20	Yizhou	2023.11.1

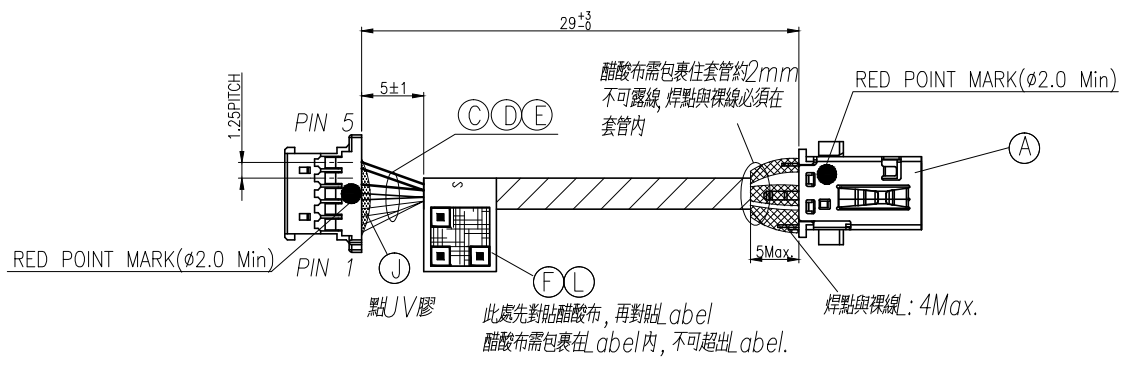

- SPECIFICATIONS:
- ELECTRICAL CHARACTERISTICS:
 - 1-1.RATING:30V 3.3A
 - 1-2.CONTACT RESISTANCE:20mΩ MAX. (INITIAL)
30mΩ MAX. (AFTER LIFE TEST)
 - 1-3.DIELECTRIC WITHSTANDING VOLTAGE:500V AC FOR ONE MINUTE.
 - 1-4.INSULATION RESISTANCE:100MΩ MIN. MEASURED BY 500V DC.
 - MECHANICAL CHARACTERISTICS:
 - 2-1.INSERTION FORCE: 1.2~2.7Kgf. (INITIAL)
 - 2-2.WITHDRAWAL FORCE: 1.0~2.7Kgf.(INITIAL)
 - 2-3.TEMPERATURE RISE CAN'T EXCEED 30°C
 - LIFE TEST:5000 CYCLES MIN.
 - OTHER GENERAL SPEC. TO REFER "2DW3127-041111F SPEC".
 - TO CONFORM TO SINGATRON HAZARDOUS SUBSTANCE FREE SPEC.
 - HALOGEN FREE PRODUCT IDENTIFICATION MARK ON JACK:
 - HALOGEN FREE PRODUCT IDENTIFICATION LABEL ON PACKAGING:
 - PRINTED DATE CODE "SYMMDD" ON TOP OF CONNECTOR.

DD: DAY
MM: MONTH
YY: YEAR
S: SINGATRON

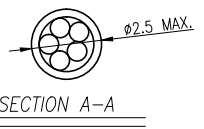
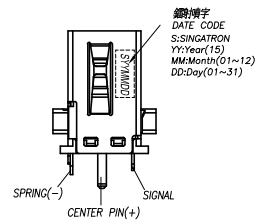
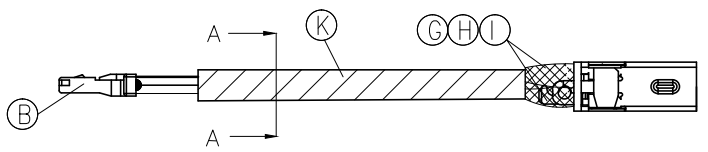

WIRE DIAGRAM		
DC POWER JACK	WIRE COLOR	CONNECTOR
CENTER PIN(+)	RED	PIN(4,5)
SPRING(-)	BLACK	PIN(2,3)
SIGNAL	WHITE	PIN(1)

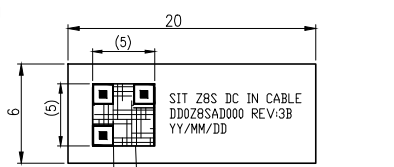
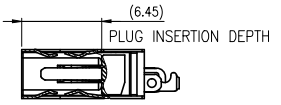
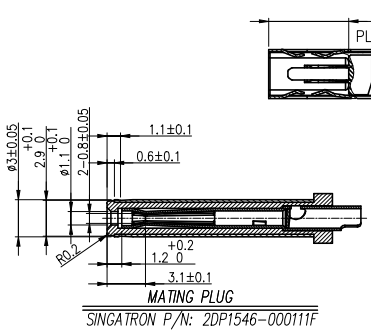

二維碼掃描內容: SITDDOZ8SAD000YYMMDD
YY: YEAR
MM: MONTH
DD: DAY
Vendor Code
Customer P/N
PPID LABEL

L	PPID LABEL	1	L20*W6	WHITE
K	ACETATE TAPE	1	T0.12	BLACK
J	UV GLUE	1	UV GLUE	WHITE
I	HEAT SHRINK TUBE	1	φ1.6(125',600V透明)	BLACK
H	HEAT SHRINK TUBE	1	φ2.5(300V 125°C)	BLACK
G	HEAT SHRINK TUBE	1	φ2.0(300V 125°C)	BLACK
F	ACETATE TAPE	1	L18*W4 T0.12	BLACK
E	WIRE	1	UL10064 26AWG	WHITE
D	WIRE	2	UL10064 26AWG	BLACK
C	WIRE	2	UL10064 26AWG	RED
B	CONNECTOR (ACES 50280)	5	TERMINAL:PHOSPHOR BRONZE	GOLD FLASH
		1	HOUSING:NYLON66 UL94V-0	WHITE
A	DC POWER JACK	1	DC JACK P/N:2DC3127-000511F(65W YELLOW)	
NO	DESCRIPTION	QTY	MATERIAL	PLATING & COLOR

UNLESS OTHERWISE SPECIFIED TOLERANCES

Singatron Enterprise Co., Ltd.
信音企業股份有限公司

DECIMALS: X :±0.5 X.X :±0.3 X.XX :±0.2

ANGLES: X :±2' X.X :±1'

TITLE: DC POWER JACK WITH WIRE HARNESS

DWN: Yizhou PART NO.2DW3127-041111F

CHKD: Boye SCALE:-- UNIT: mm

APVD: Liao SIZE: A3 SHEET:1 OF 1 REV:D

CUSTOMER COPY