

REV.	ECN NO OR DESCRIPTION	REVISED	DATE
A	PDR No. T221012-1A	JIE-FU	2023.05.17
B	ECN No. S202307-C18	Kesheng	2023.08.04
C	ECN No. S202308-C19	Yizhou	2023.10.11
D	ECN No. S202307-C20	Yizhou	2023.11.1

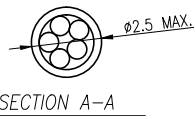

WIRE DIAGRAM		
DC POWER JACK	WIRE COLOR	CONNECTOR
CENTER PIN(+)	RED	PIN(4,5)
SPRING(-)	BLACK	PIN(2,3)
SIGNAL	WHITE	PIN(1)

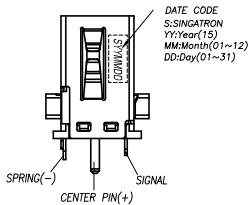
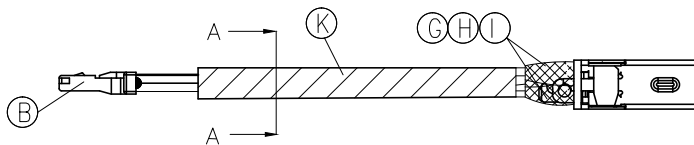
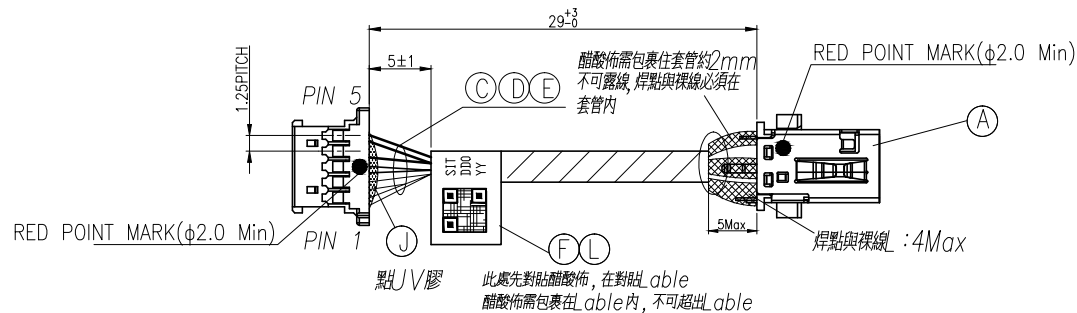
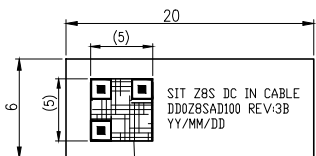
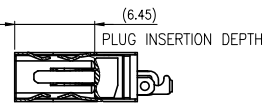
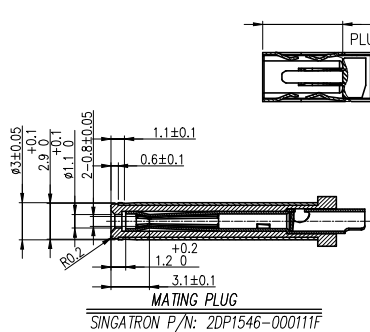

二維碼清晰, 可掃描, 無空格, 共20碼

二維碼掃描內容: SITDDOZ8SAD100YYMMDD

Vendor Code _____ YY: YEAR
Customer P/N _____ MM: MONTH
PPID LABEL _____ DD: DAY

SPECIFICATIONS:

- ELECTRICAL CHARACTERISTICS:
 - 1-1. RATING: 30V 3.3A
 - 1-2. CONTACT RESISTANCE: 20mΩ MAX. (INITIAL)
30mΩ MAX. (AFTER LIFE TEST)
 - 1-3. DIELECTRIC WITHSTANDING VOLTAGE: 500V AC FOR ONE MINUTE.
 - 1-4. INSULATION RESISTANCE: 100MΩ MIN. MEASURED BY 500V DC.
- MECHANICAL CHARACTERISTICS:
 - 2-1. INSERTION FORCE: 1.2~2.7Kgf. (INITIAL)
 - 2-2. WITHDRAWAL FORCE: 1.0~2.7Kgf. (INITIAL)
 - 2-3. TEMPERATURE RISE CAN'T EXCEED 30°C
- LIFE TEST: 5000 CYCLES MIN.
- OTHER GENERAL SPEC. TO REFER "2DW3127-044111F SPEC".
- TO CONFORM TO SINGATRON HAZARDOUS SUBSTANCE FREE SPEC.
- HALOGEN FREE PRODUCT IDENTIFICATION MARK ON JACK:
- HALOGEN FREE PRODUCT IDENTIFICATION LABEL ON PACKAGING:
- PRINTED DATE CODE "SYMMDD" ON TOP OF CONNECTOR.

DD: DAY
MM: MONTH
YY: YEAR
S: SINGATRON

L	ACETATE TAPE	1	L18*W4 T0.12	BLACK
K	ACETATE TAPE	1	T0.12	BLACK
J	UV GLUE	1	UV GLUE	WHITE
I	HEAT SHRINK TUBE	1	φ1.6(125',600V)	BLACK
H	HEAT SHRINK TUBE	1	φ2.5(300V 125°C)	BLACK
G	HEAT SHRINK TUBE	1	φ2.0(300V 125°C)	BLACK
F	PPID LABEL	1	L20*W6	WHITE
E	WIRE	1	UL10064 26AWG	WHITE
D	WIRE	2	UL10064 26AWG	BLACK
C	WIRE	2	UL10064 26AWG	RED
B	CONNECTOR (ACES 50280)	5	TERMINAL: PHOSPHOR BRONZE	GOLD FLASH
		1	HOUSING: NYLON66 UL94V-0	WHITE
A	DC POWER JACK	1	DC JACK P/N: 2DC3127-003111F(90W BLUE)	
NO	DESCRIPTION	QTY	MATERIAL	PLATING & COLOR

UNLESS OTHERWISE SPECIFIED TOLERANCES



Singatron Enterprise Co., Ltd.
信音企業股份有限公司

DECIMALS: X : ±0.5
X.X : ±0.3
X.XX : ±0.2

ANGLES: X : ±2'
X.X : ±1'

TITLE	DC POWER JACK WITH WIRE HARNESS		
DWN	Yizhou	PART NO. 2DW3127-044111F	
CHKD	Boye	SCALE: --	UNIT: mm
APVD	Liao	SIZE: A3	SHEET: 1 OF 1
			REV: D

CUSTOMER COPY