

REV.	ECN NO OR DESCRIPTION	REVISED	DATE
A	PDR RELEASE	IVY-C	2016.04.18
B	ECN NO: L160087	IVY-C	2016.06.29

SPECIFICATIONS:

- ELECTRICAL CHARACTERISTICS:
 - CURRENT RATING: 0.3 AMP.
 - VOLTAGE RATING: 40V.
 - INITIAL CONTACT RESISTANCE EXCLUDING CONDUCTOR RESISTANCE: 10mΩ MAX (TARGET DESIGN VALUE). AFTER TEST: Δ 30mΩ MAX.
 - INSULATION RESISTANCE: 100MΩ MIN. @ 500V DC.
 - DIELECTRIC WITHSTANDING VOLTAGE: 250V AC FOR 1 MINUTE.
- MECHANICAL CHARACTERISTICS:
 - INSERTION FORCE: 4.5Kgf MAX.
 - WITHDRAWAL FORCE: 0.5~2.5Kgf.
- LIFE TEST: 5,000 CYCLES
- OTHER GENERAL SPEC. TO REFER "HDMI SERIES SPEC".
- TO CONFORM TO THE SINGATRON HAZARDOUS SUBSTANCE FREE SPEC.
- HALOGEN FREE PRODUCT IDENTIFICATION LABEL ON PACKAGING:
- PACKAGE: SEE "2HE1703-003111F" PACKAGE.
- FOR REFLOW SOLDERING LEAD-FREE PROCESS.

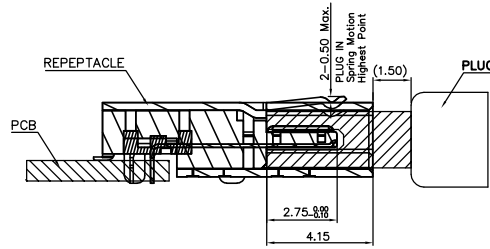
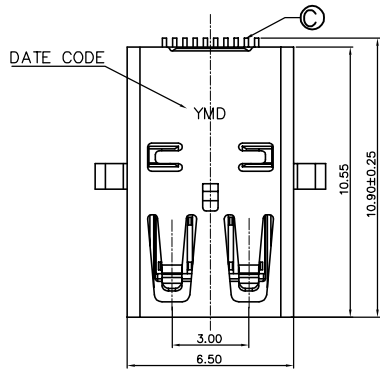

PULG INSERTION DEPTH

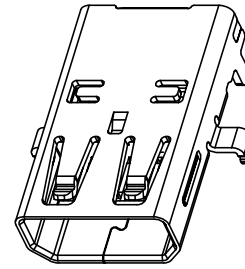

3D VIEW

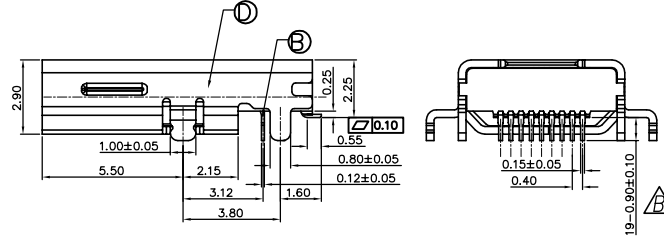
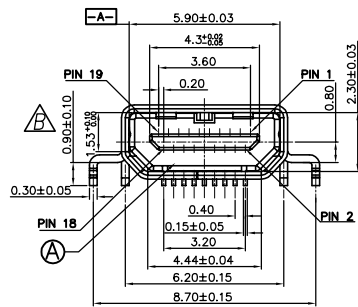

PART NO.
2HE1703-003111F

SUFFIX: HALOGEN FREE

PACKAGE
1: TAPE AND REEL

HOUSING COLOR
1: BLACK

CONTACT PLATING

1: GOLD FLASH ON CONTACT AREA AND GOLD FLASH ON SOLDER AREA
50u" NICKEL UNDER PLATED

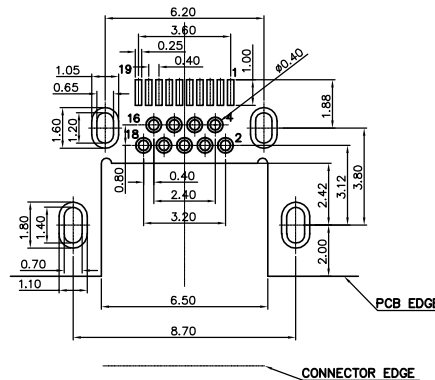
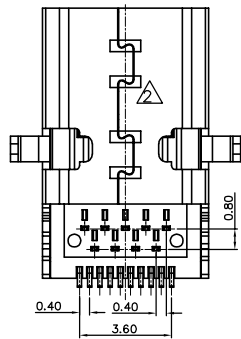

RECOMMENDED PCB LAYOUT(TOP VIEW)
THICKNESS=0.8mm
TOLERANCE UNSPECIFIED=±0.05mm)

D	SHELL	1	SUS304-1/2H	NICKEL PLATED 40~100u"
C	SMT CONTACT	10	C5191-R/H	SEE PART NO.
B	DIP CONTACT	9	C5191-R/H	SEE PART NO.
A	HOUSING	1	LCP UL 94V-0	BLACK
NO	DESCRIPTION	QTY	MATERIAL	PLATING & COLOR
UNLESS OTHERWISE SPECIFIED TOLERANCES			Singatron Enterprise Co., Ltd. 信音企業股份有限公司	
DECIMALS:		ANGLES:	TITLE	
X	:±0.5	X	:±2°	HDMI D TYPE FEMALE, DIP, CH=0.80
X.X	:±0.3	X.X	:±1°	DWN
X.XX	:±0.2			IVY-C 2016.06.29 PART NO. 2HE1703-003111F
				CHKD
				ANGELA2016.06.29 SCALE 2.5:1 UNIT: mm
				APVD
				ANGELA2016.06.29 SIZE: A3 SHEET: 1 OF 1 REV: B
CUSTOMER COPY				