

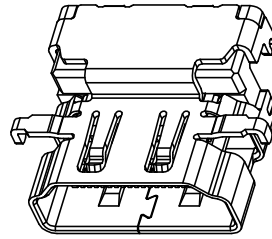

REV.	ECN NO OR DESCRIPTION	REVISED	DATE
A	PDR NO: S160519-4A	JTTLUCKY	2016.11.24

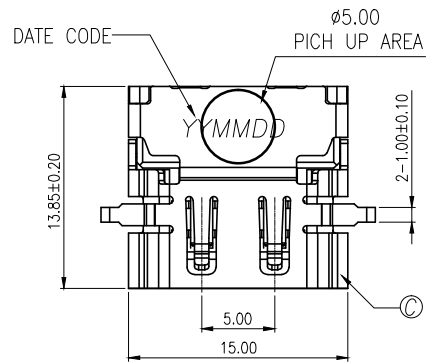

3D VIEW

SPECIFICATIONS:

- Contact current Rating: 1.5 Amperes
- Dielectric Withstanding Voltage: AC 150V(RMS)
- Insulation resistance: 500Megohms Minimum.
- Contact Resistance: 30mΩ Max. 50mΩ Max for other contacts
- Mechanical Characteristics:
 - Mating Force: 45 Newtoms. Maximum
 - Unmating Force: 10 Newtoms. Minimum.
- OTHER GENERAL SPEC. TO REFER "2HE3Y76-000111F_SPEC".
- TO CONFORM TO SINGATRON HAZARDOUS SUBSTANCE FREE SPECIFICATION
- HALOGEN FREE PRODUCT IDENTIFICATION LOGO ON PACKAGING: 
- PACKAGING: TAPE & REEL

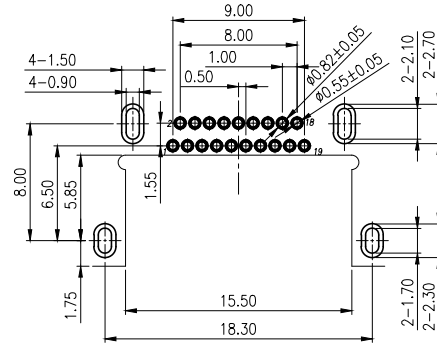
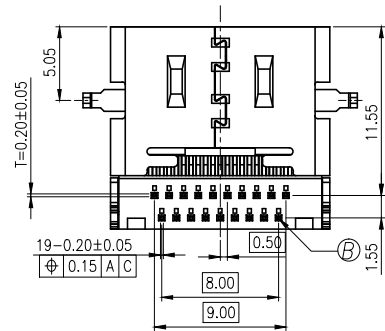
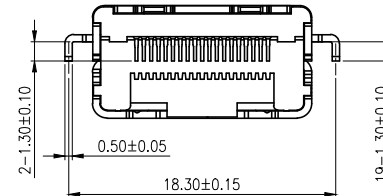
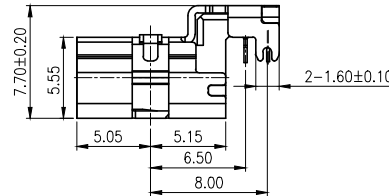
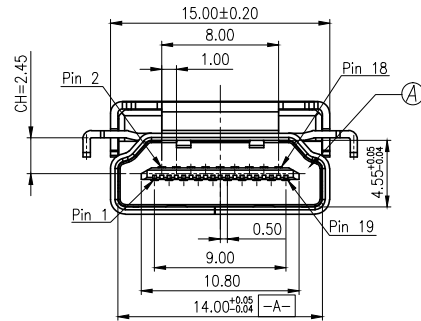

RECOMMENDED PCB LAYOUT (COMPONENT SIDE) TOP VIEW
DEFAULT TOLERANCES ±0.05mm P.C.B THICKNESS=1.00mm

C	SHELL	1	STAINLESS STEEL T=0.5	OVER BRIGHT Ni 50u"MIN.
B	CONTACT	19	COPPER ALLOY, T=0.20	Au 1u" PLATING ON CONTACT AREA; 100u" MIN. MATTE TIN PLATING ON SOLDERTAILS; 60u" MIN. NICKEL UNDER PLATING OVERALL;
A	HOUSING	1	LCP +30% G.F UL 94V-0	BLACK
NO	DESCRIPTION	QTY	MATERIAL	PLATING & COLOR

UNLESS OTHERWISE SPECIFIED TOLERANCES

Singatron Enterprise Co., Ltd.
信音企業股份有限公司

DECIMALS:	ANGLES:	TITLE	HDMI A TYPE FEMAL, SINKING, CH=2.45	
X : ±0.5	X : ±2°	DWN	Jttlucky	PART NO. 2HE3Y76-000111F
X.X : ±0.3	X.X : ±1°	CHKD	James	SCALE: 2:1 UNIT: mm
X.XX : ±0.2		APVD	Boye	SIZE: A3 SHEET: 1 OF 1 REV: A

CUSTOMER COPY