

REV. A	ECN NO OR DESCRIPTION	REVISED	DATE
	PRODUCT RELEASE	ZhenYu	2021.06.16

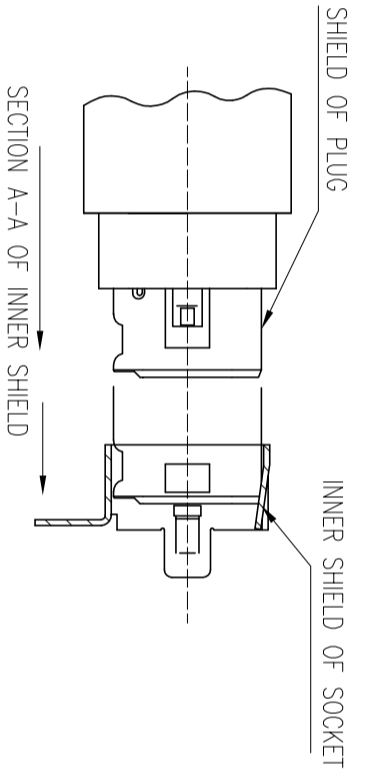

- SPECIFICATIONS:
- ELECTRICAL CHARACTERISTICS:
 - RATING: 20V, 12A
 - CONTACT RESISTANCE:
 - 30 MILLIOHMS Max. FOR INITIAL,
 - 60 MILLIOHMS Max. AFTER 5000 CYCLES.
 - INSULATION RESISTANCE: 50 MEGAOHMS Min. BY 250V DC AFTER ONE MINUTE.
 - DIELECTRIC WITHSTANDING VOLTAGE: 250V RMS AFTER ONE MINUTE.
 - MECHANICAL CHARACTERISTICS:
 - INSERTION FORCE : 4.0KGF MAX
 - WITHDRAWAL FORCE : 0.5~3KGF
 - LIFE TEST: 5,000 CYCLES MIN.
 - OTHER GENERAL SPEC. TO REFER "2MJ-0402A1M2F SPEC".
 - TO CONFORM TO SINGATRON HAZARDOUS SUBSTANCE FREE SPEC.
 - GREEN PRODUCT IDENTIFICATION MARK ON JACK: ☉
 - GREEN PRODUCT IDENTIFICATION LABEL ON PACKAGING:
 - CPK CONTROLLED DIMENSION.
 - PRINTED DATE CODE "YYMMDD" ON TOP OF CONNECTOR.

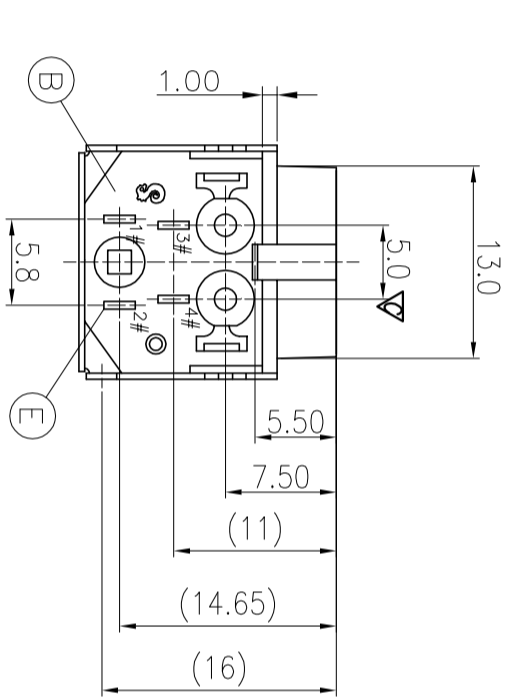
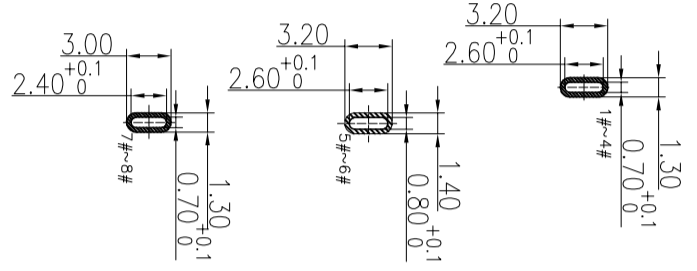
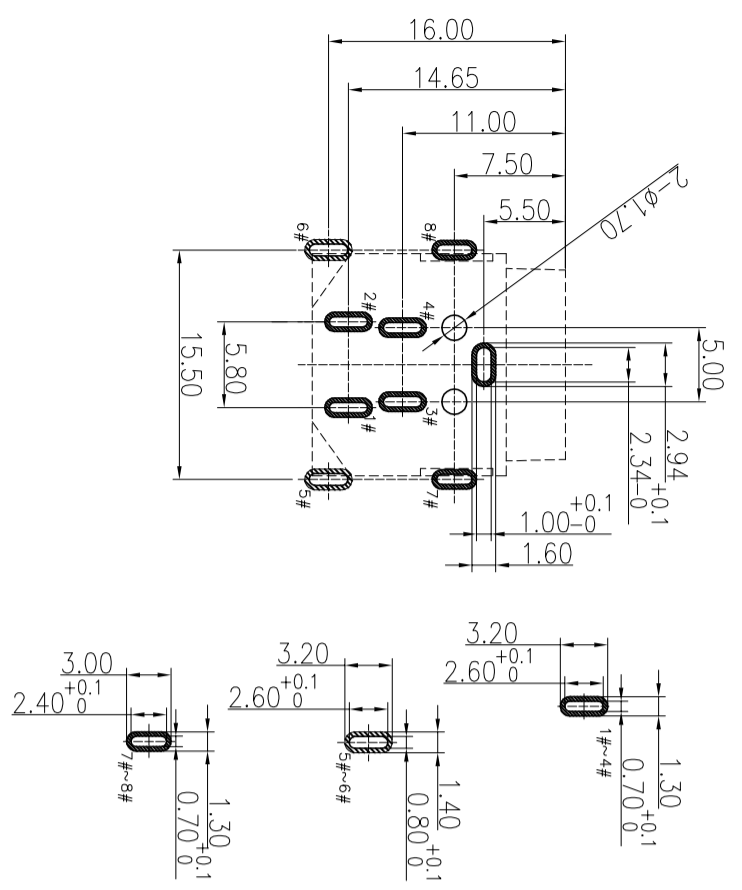
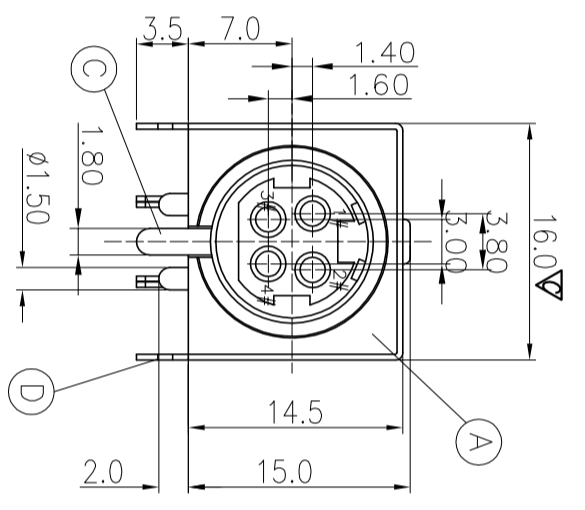
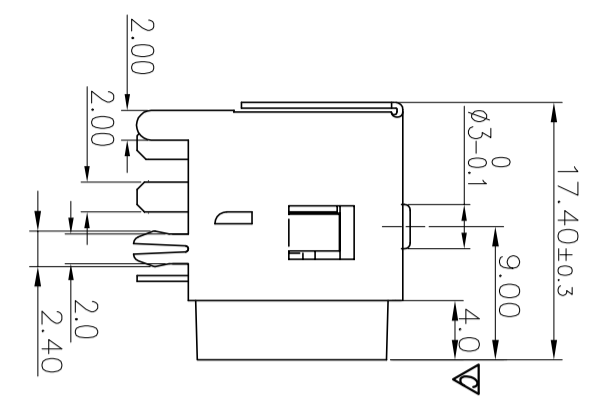
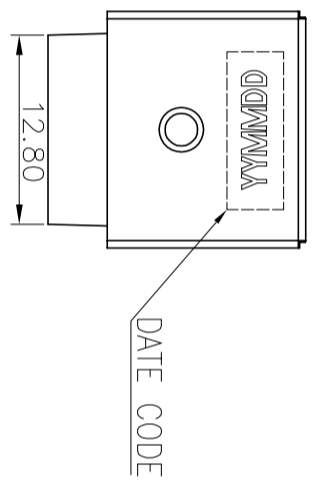
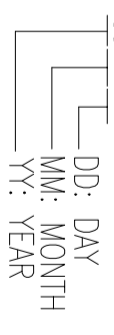

NO	DESCRIPTION	QTY	MATERIAL	PLATING & COLOR
E	CONTACT TERMINAL	4	PHOSPHOR BRONZE 0.3T	SILVER PLATING
D	OUTER SHIELD	1	BRASS 0.4T	Ni: 60u" Min
C	INNER SHIELD	1	BRASS 0.4T	NICKEL PLATING
B	COVER	1	PA10T+30% Vicnyl	BLACK COLOR
A	BODY	1	R630NH	

Singatron Enterprise Co., Ltd.
信音企業股份有限公司

DECIMALS:	ANGLES:	TITLE	4P SOCKET
X :±0.5	X :±2°	DWN	ZhenYu Qi
X.X :±0.3	X.X :±1°	CHKD	Stone Zhu
X.XX :±0.2		APVD	Jim Deng
PART NO. 2MJ-0402A1M2F			
SCALE 1:1			
UNIT: mm			
SIZE: A3			
SHEET: 10F1			
REV: A			

RECOMMENDED PCB LAYOUT
(TOP VIEW)(TOL. ±0.05)

