

REV.	ECN NO OR DESCRIPTION	REVISED	DATE
A	PRODUCT RELEASE	ZhenYu	2021.11.25
B	ECN NO.: C202212-C01 增加PLUG Mating示意图	Zhongjian	2023.01.10

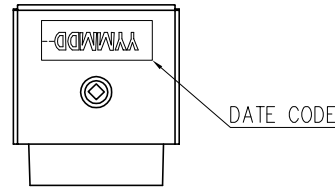
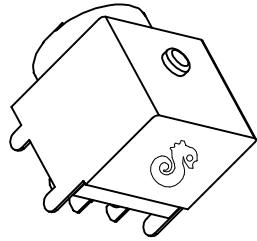

SPECIFICATIONS:

1. ELECTRICAL CHARACTERISTICS:

- 1-1. RATING: 20V 11A
- 1-2. CONTACT RESISTANCE: INITIAL 30mΩ MAX.  
AFTER LIFE TEST 60mΩ MAX.
- 1-3. DIELECTRIC WITHSTANDING VOLTAGE: 1500V AC FOR ONE MINUTE.
- 1-4. INSULATION RESISTANCE: 100MΩ MIN. MEASURED BY 250V DC

2. MECHANICAL CHARACTERISTICS:

- 2-1. INSERTION FORCE : 1.0~4.0 kgf (INITIAL / AFTER LIFE TEST)
- 2-2. WITHDRAWAL FORCE : 1.0~4.0 kgf (INITIAL / AFTER LIFE TEST)

3. LIFE TEST: 5,000 CYCLES

4. OTHER GENERAL SPEC. TO REFER "2MJ-3432 SERIES SPEC".

5. TO CONFORM TO SINGATRON HAZARDOUS SUBSTANCE FREE SPEC.

6. HALOGEN FREE PRODUCT IDENTIFICATION MARK ON JACK (A)

7. GREEN PRODUCT IDENTIFICATION LABEL ON PACKAGING (B)

8. FOR REFLOW SOLDERING LEAD-FREE PROCESS.

9. PRINTED DATE CODE "YY MM DD" ON TOP OF CONNECTOR.

DD: DAY  
MM: MONTH  
YY: YEAR

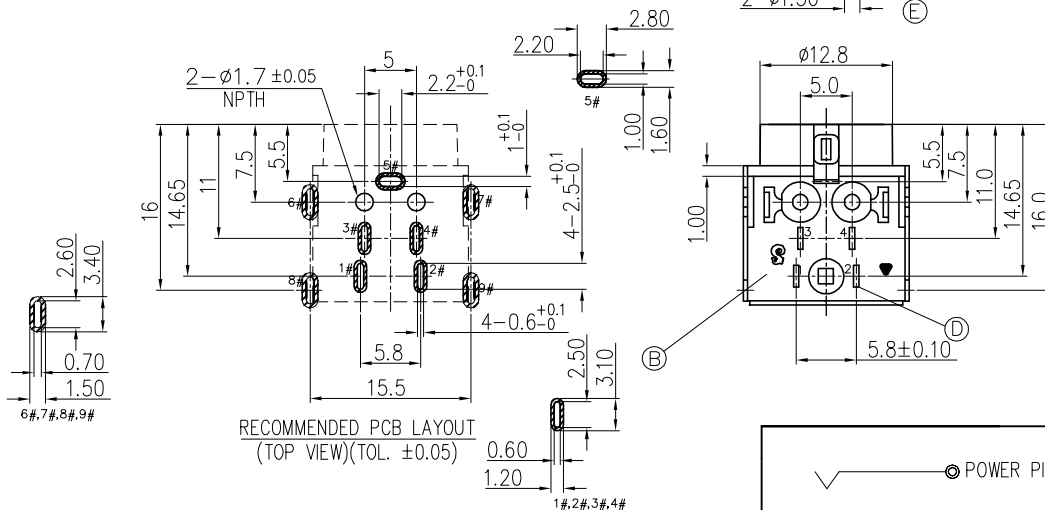
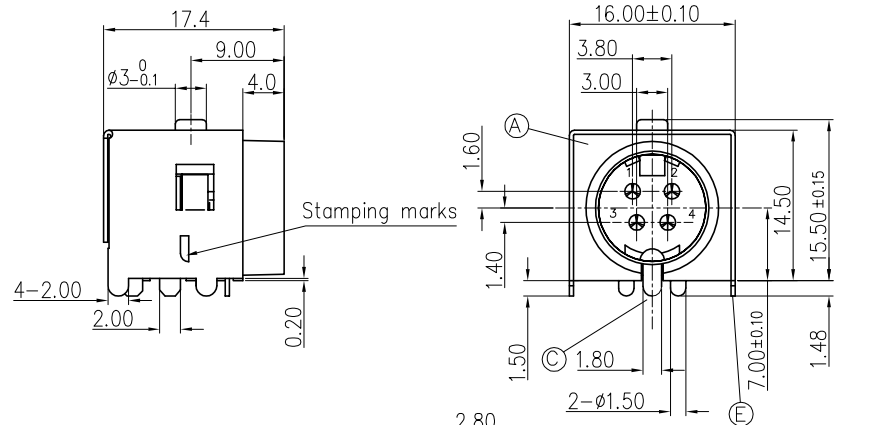
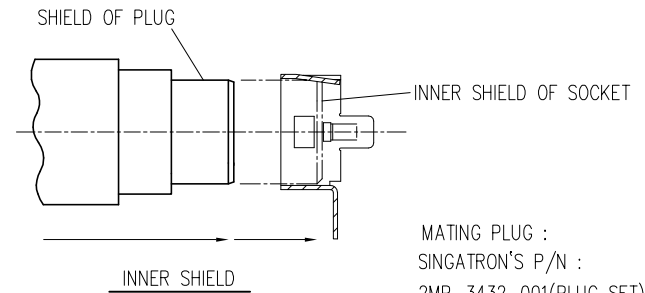

PIN DEFINE			
PIN NO.	1#,2#,3#,4#	5#	6#,7#,8#,9#
SIGNAL NAME	POWER PIN	GROUND PIN	SHELL

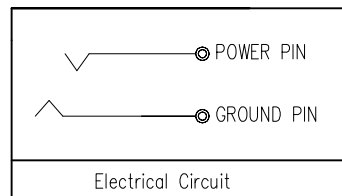

E	OUTER SHIELD	1	COPPER ALLOY 0.4T	NICKEL PLATING
D	CONTACT PIN	4	COPPER ALLOY 0.3T	SILVER PLATING
C	INNER SHIELD	1	COPPER ALLOY 0.4T	NICKEL PLATING
B	COVER	1	PA10T+30% GF,VICNYL R630NH	BLACK COLOR
A	BDDY	1		
NO	DESCRIPTION	QTY	MATERIAL	PLATING & COLOR

UNLESS OTHERWISE SPECIFIED TOLERANCES		Singatron Enterprise Co., Ltd. <b>信音企業股份有限公司</b>		
DECIMALS:	ANGLES:	TITLE	POWER SOCKET	
X : ±0.5	X : ±2'	DWN	Zhongjian-Wu	PART NO: 2MJ-3432-019F
X.X : ±0.3	X.X : ±1'	CHKD	Stone-Zhu	SCALE 2:1 UNIT: mm
X.XX : ±0.2		APVD	Jim-Deng	SIZE: A3 SHEET: 1 OF 3 REV: B
CUSTOMER COPY				

REV.	ECN NO OR DESCRIPTION	REVISED	DATE
B	ECN NO.: C202212-C01 增加PLUG Mating示意圖	Zhongjian	2023.01.10

Description of plug-in travel and contact status:

1. Grounding Contact Position

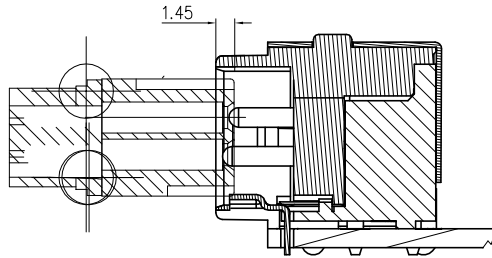

2. Negative contact Position

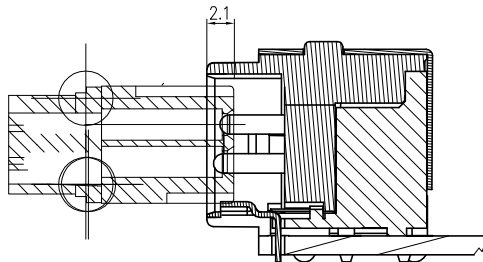

3. Positive contact Position

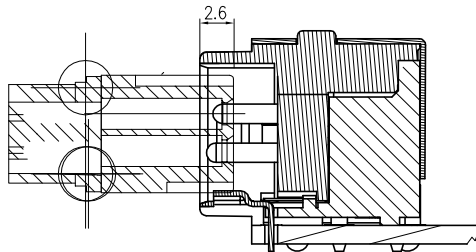

4. Plug-in limit Position

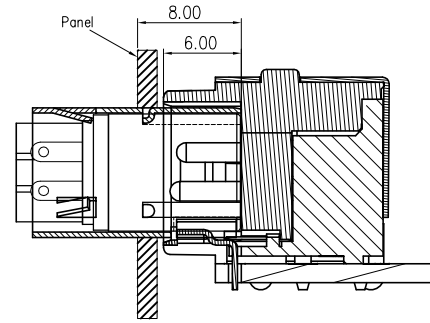

NO	DESCRIPTION	QTY	MATERIAL	PLATING & COLOR
UNLESS OTHERWISE SPECIFIED TOLERANCES		 Singatron Enterprise Co., Ltd. <b>信音企業股份有限公司</b>		
DECIMALS: ANGLES:		TITLE: POWER SOCKET		
X	:±0.5 X :±2°	DWN	Zhongjian-Wu	PART NO. 2MJ-3432-019F
X.X	:±0.3 X.X :±1°	CHKD	Stone-Zhu	SCALE 4:1 UNIT: mm
X.XX	:±0.2	APVD	Jim-Deng	SIZE: A3 SHEET: 20F3 REV: B
CUSTOMER COPY				