

REV.	ECN.NO.	DATE
A	RELEASED	12/04-'06
B	Add the Screw	08/04-'10
C	Modify 3d View	10/29-'12

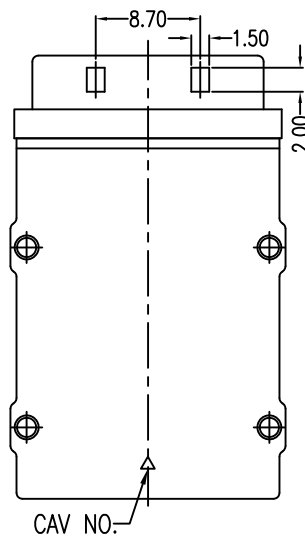
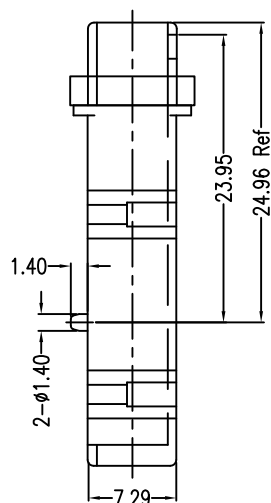
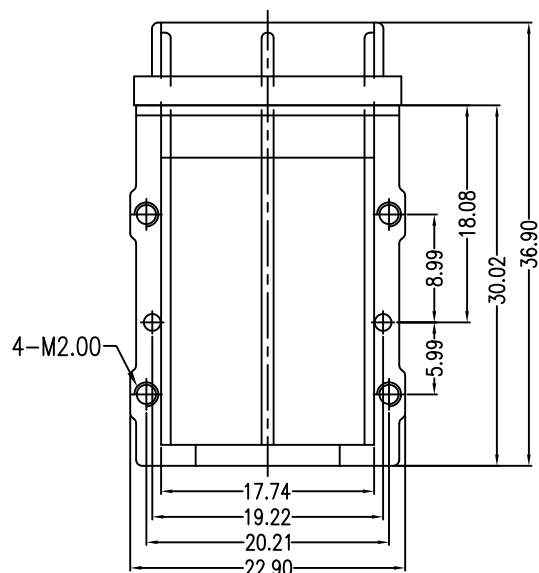
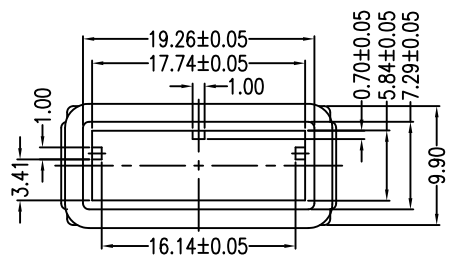

**NOTES:**

**\*Material**

Body: Zn Alloy  
 Plating: Ni Plating Over All  
 EMC Gasket: Elastomer, UL94V-0

**\*Mechanical**

The Cable Retention Force: 20lbf Min

**\*Others**

Our Company's Usual Specification is Without Screw

**\*How to Order:**

2MSA-S26-R5S-50  
 Blank: 1X(Without Screw)  
 3: 1X(With Screw)  
 Series NO.

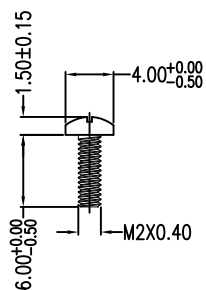

**SCREW**

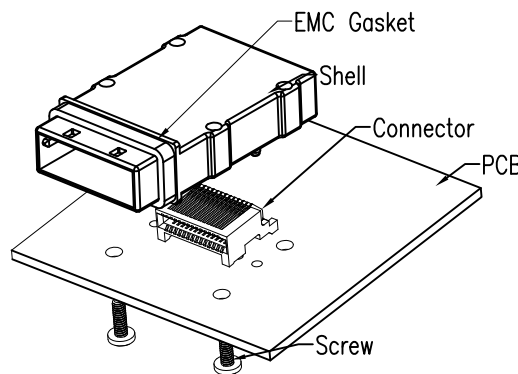
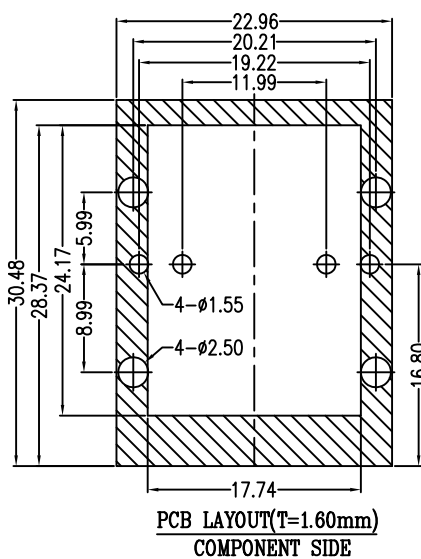

Units	mm	Scale	3:2	Drawing By	Data	SINGATRON U.S.A.							
Tolerance Unless Otherwise Specified				May	10/31-'12	Date	10/29-'12	Title	Mini SAS 26P Shell (1X)	Drawing No.	2MSA-S26-R5S-50	REV	C
.X	~ ±0.38	Reviewed By	Data	Sharon	10/31-'12	Sheet	1 of 1						
.XX	~ ±0.25	Approval By	Data	Jason	10/31-'12	Third Angle Projection		Universal Key					
.XXX	~ ±0.20												
Angle	~ ± 3°												