

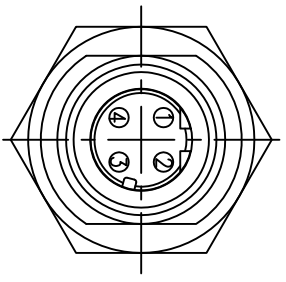

REV.	ECN NO OR DESCRIPTION	REVISED	DATE
A	PDR NO.:T110315-1A	Shown	2011.08.13

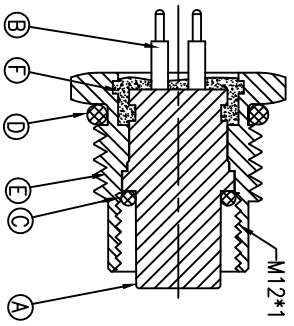
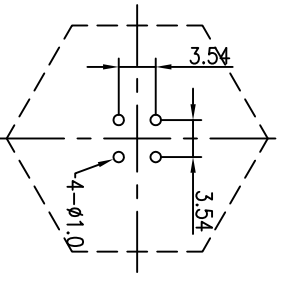
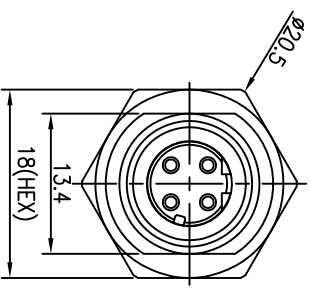
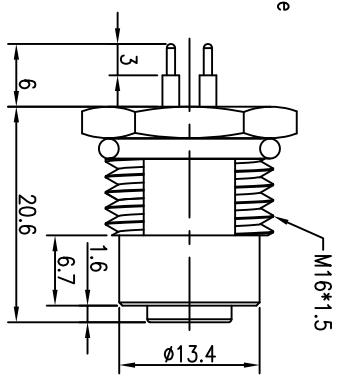
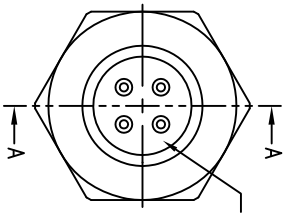
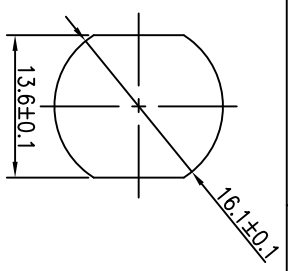

- NOTES:
1. WATERPROOF RATE: IP68
IP68: IMMersed IN 1M WATER FOR 24 HOURS
 2. ELECTRICAL CHARACTERISTICS
TEMPERATURE RANGE: -40°C TO +100°C
RATING: 60V AC/DC 5A
DIELECTRIC WITHSTANDING VOLTAGE: 500V AC FOR ONE MINUTE
 3. SPECIFICATIONS:SEE "M12 SERIES SPECIFICATIONS".
 4. TO CONFORM TO SINGATRON HAZARDOUS SUBSTANCE FREE SPEC.
 5. GREEN PRODUCT IDENTIFICATION LABEL ON PACKAGING: 
 6. FOR PANEL THICKNESS MAX OF 4.0mm

F	LIQUID GLUE	1	N/A	BLACK
E	SHIELD	1	BRASS	NICKEL PLATING 60μ"
D	O-RING	1	EPDM	BLACK
C	O-RING	1	VITON	RED
B	FEMALE PIN	4	Phosphor Bronze	6μ" GOLD PLATING OVER NICKEL PLATING
A	BODY	1	NYLON+33%GF	BLACK
NO	DESCRIPTION	QTY	MATERIAL	PLATING & COLOR
UNLESS OTHERWISE SPECIFIED TOLERANCES				
DECIMALS: ANGLES:				
X	:±0.5	X	:±2°	
X.X	:±0.3	X.X	:±1'	
X:XX	:±0.2			
 Singatron Enterprise Co., Ltd. 信亨企業股份有限公司				
TITLE: M12 SERIES FRONT MOUNT F CONN				
D CODE: 4PIN HEXAGONAL BACKSHELL				
DWN	Shown	PART NO.	2MT3D04-W04300H	
CHKD	Steve	SCALE	2:1	UNIT: mm
APVD	Tony	SIZE: A3	SHEET: 1 OF 1	REV: A
CUSTOMER COPY				