

REV	ECN NO	OR DESCRIPTION	REVISED	DATE
A	PDR NO.:	C190320-2A	RZ	2021.12.28

- NOTES:
- ELECTRICAL CHARACTERISTICS:
 - 1-1 CURRENT RATING: 20 AMPS.
 - 1-2 CONTACT RESISTANCE: 30 mOhm Max.
 - 1-3 INSULATION RESISTANCE: 100 MOhm Min. at 500VDC.
 - 1-4 BREAKDOWN VOLTAGE: 1000 VAC PER MINUTE.
 - MECHANICAL CHARACTERISTICS:
 - 2-1 TIGHTENING TORQUES: 1.0~1.2Nm(8.85~10.62lbf.in.).
 - 2-2 CONTACT RECOMMENDATION: 18 AWG.
 - ENVIRONMENTAL:
 - 3-1 OPERATING TEMPERATURE: -40°C TO +105°C.
 - 3-2 SEALING REQUIREMENTS: IP67.
 - SEAL FOR CABLE OD: $\phi 5.5\text{mm} \sim \phi 9.0\text{mm}$
 - LIFE TEST: 1,000 CYCLES MIN.
 - OTHER GENERAL SPEC TO REFER "QUICK SERIES GENERAL SPEC".
 - FOR TECHNICAL DATA REFER TO YOUR LOCAL SINGARON ELECTRONICS SALES OFFICE.
 - ALL DIMENSIONS ARE NOMINAL FOR REFERENCE ONLY UNLESS OTHERWISE STATED.
 - TO CONFORM TO SINGARON HAZARDOUS SUBSTANCE FREE SPEC.
 - GREEN PRODUCT IDENTIFICATION LABEL ON PACKAGING: **GREEN**.
 - Ⓚ CRIMP TOOL SIZE(0.100"HEX).

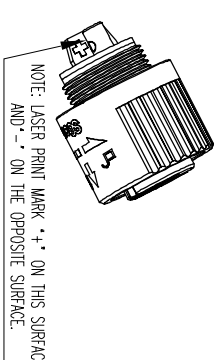

CONN1 POWER JACK	
2	-V
1	+V

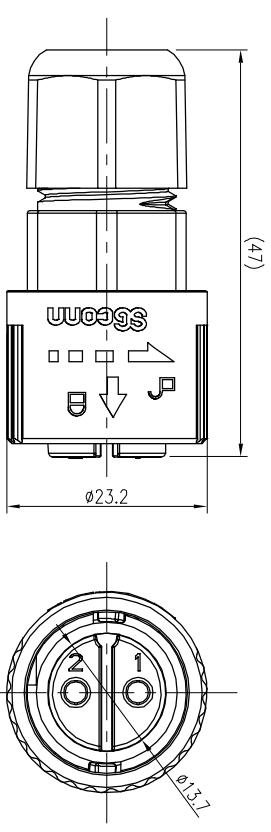
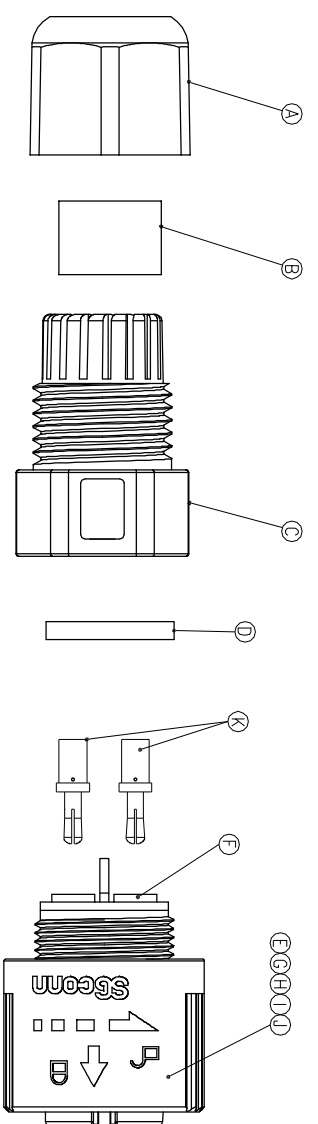
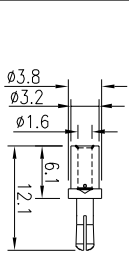
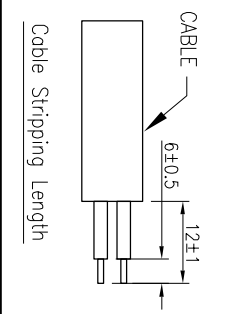
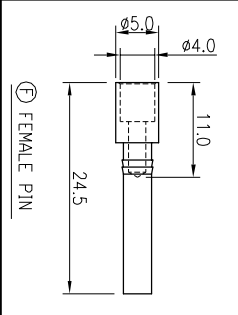
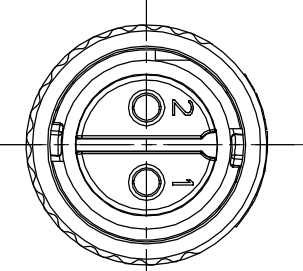

Ⓚ Crimp Pin
Crimp pin will be shipped as the attachment

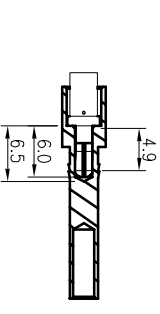

NO	DESCRIPTION	QTY	MATERIAL	PLATING & COLOR
A	SEALING NUT	1	PA66	BLACK
B	SEAL	1	SILICONE	BLACK
C	CLAMP RING	1	PC	BLACK
D	GASKET	1	SILICONE	BLACK
E	LOCK NUT	1	PC	GRAY
F	FEMALE PIN	2	Phosphor Bronze C5441	30U" AU PLATING OVER NICKEL PLATING
G	LIQUID GLUE	1	N/A	BLACK
H	BODY	1	PA66	BLACK
I	SPRING	1	SUS	N/A
J	O-RING	1	SILICONE	BLUE
K	Crimp Pin	4	C3602	Gold flash Plating Over Nickel Plating

UNLESS OTHERWISE SPECIFIED TOLERANCES

DECIMALS: ANGLES:
X :±0.5 X :±2
X.X :±0.3 X.X :±1'
X.XX :±0.2

TITLE	CIRCUAR SERIES QUICK TYPE MIDDLE SIZE
DWN	RZ
CHKD	Jun
APVD	JF

Suzhou Singatron Auto Electronics CO.,LTD.
苏州信音汽车电子有限公司

PART NO. 2QM3032-W02602H
SCALE 2:1 UNIT: mm
SIZE: A3 SHEET: 1 OF 1 REV: A

CUSTOMER COPY