

REV. ECN NO OR DESCRIPTION	REVISED	DATE
A PDR RELEASE	EVEN	2020.10.21

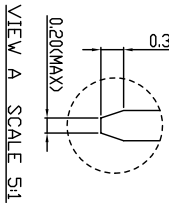

- SPECIFICATIONS:**
- VOLTAGE RATING: 150 VAC MAX.
  - CURRENT RATING: 1.5 AMP MAX.
  - INSULATION RESISTANCE: 1000M OHMS MIN. AT 500 VDC.
  - DIELECTRIC WITHSTANDING VOLTAGE: 1000 VAC 60HZ 1 MINUTE.
  - DURABILITY: 5000 CYCLES.
  - OPERATING TEMPERATURE: -30C TO +70C.
  - OTHER GENERAL SPEC. TO REFER "2R11660-010211F SPEC".
  - TO CONFORM TO SINGATRON HAZARDOUS SUBSTANCE FREE SPEC.
  - HALOGEN FREE PRODUCT IDENTIFICATION LABEL ON PACKAGING.
  - PACKAGE: SEE "2R11660-010211F" PACKAGE.
  - FOR REFLOW SOLDERING LEAD-FREE PROCESS.
  - FOR MATES WITH MODULAR PLUG CONFORMING TO FCC PART 68, SUBPART F.

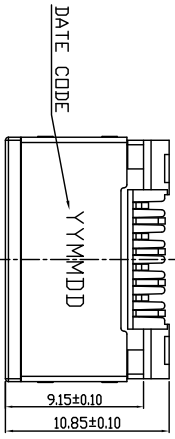
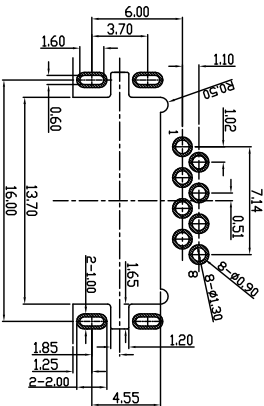
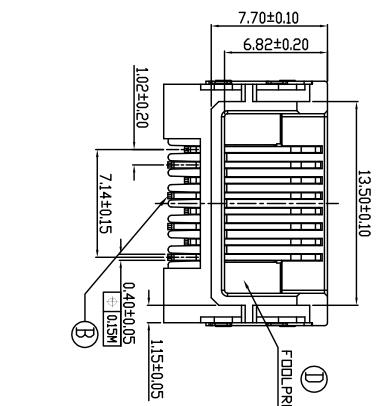
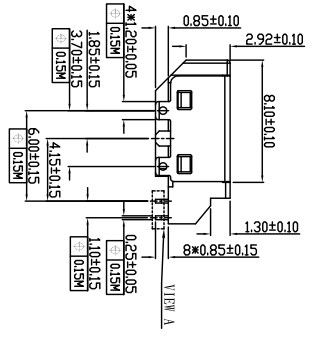
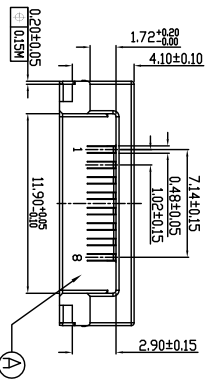
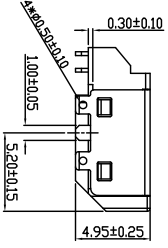

RECOMMENDED PCB LAYOUT  
TOLERANCE=±0.05mm

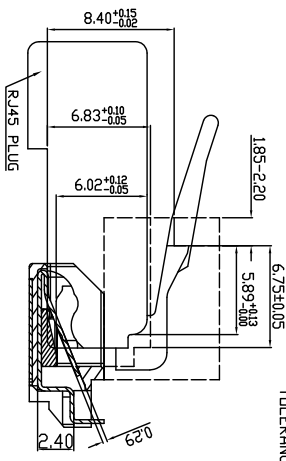
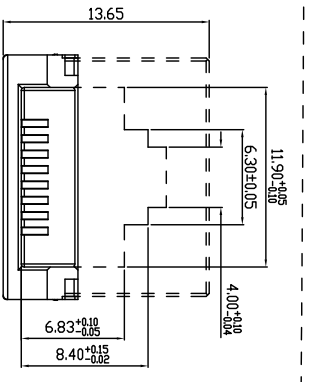

**PART NO.**  
**2R11660-010211F**

- SUPPLY: HALOGEN FREE
- PACKAGE
- 1: TAPE AND REEL
- HOUSING COLOR
- 1: BLACK
- CONTACT AREA PLATING
- 2: GOLD 30u" ON CONTACT AREA,
- 50u" MIN.MATTE TIN(Sn) PLATED ON SOLDER AREA.
- 30u" MIN.NICKEL UNDERPLATED OVERALL.

D	DEFEND	2	LCP UL 94V-0	BLACK
C	SHIELD	1	SUS201	30u"~100u" NICKEL
B	CONTACT	8	C5210	SEE PART NO.
A	HOUSING	1	PAT10 UL 94V-0	BLACK
NO	DESCRIPTION	QTY	MATERIAL	PLATING & COLOR

Singatron Enterprise Co., Ltd.  
信音企業股份有限公司

TITLE	RJ45 HALF JACK, W/SHIELD, DIP TYPE, H=4.10mm		
DWN	REV 2020.10.21	PART NO.	2R11660-010211F
CHKD	SCALE 3/1 UNIT: mm		
APVD	AMEL2020.10.21	SIZE: A3	SHEET: 1 OF 1 REV: A

CUSTOMER COPY