

REV.	ECN NO. OR DESCRIPTION	REVISED	DATE
A	PDR NO.:T120927-1A	Som	2012.12.15
B	ECN NO.:S140136	ALLEN	2014.05.15
C	ECR NO.:S151014-E	ALLEN	2015.10.19

**SPECIFICATIONS:**

- ELECTRICAL CHARACTERISTICS:**
  - CURRENT RATING: 1.5A MAX.
  - VOLTAGE RATING: 150V MAX.
  - CONTACT RESISTANCE : 50mΩ MAX (INITIAL), 100mΩ MAX (AFTER LIFE TEST), 100mΩ RESISTANCE : 100mΩ MIN.
- MECHANICAL CHARACTERISTICS:**
  - DURABILITY: 5000 CYCLES.
  - INSERTION FORCE: 2.25kg MAX. WITH LATCH DEPRESSED.
  - WITHDRAWAL FORCE: 4.5kg MAX. WITH LATCH DEPRESSED.
  - OPERATING TEMPERATURE:-30°C ~ +70°C.
- MARKING: MARK "S" INSIDE OF THE CONNECTOR.
- PACKAGING : TAPE & REEL.
- TO CONFORM TO SINGATRON HAZARDOUS SUBSTANCE FREE SPEC.
- HALOGEN FREE PRODUCT IDENTIFICATION MARK ON PRODUCT: ○
- HALOGEN FREE PRODUCT IDENTIFICATION LOGO ON THE PACKAGING: ●
- FOR REFLOW SOLDERING LEAD-FREE PROCESS.
- PRINTED DATE CODE "YY MM DD" ON TOP OF THE CONNECTOR.

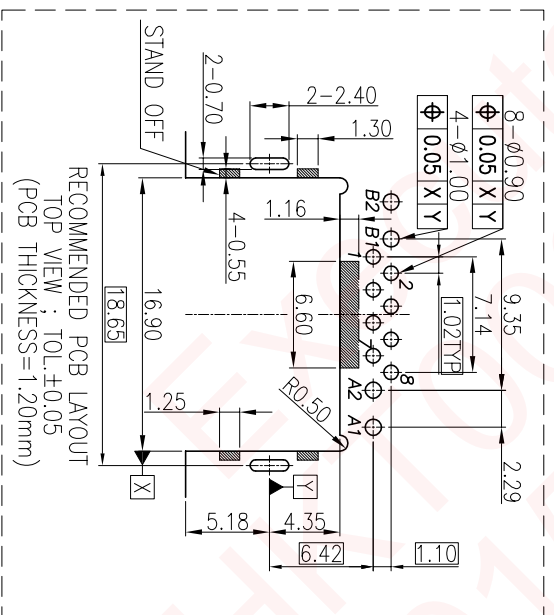
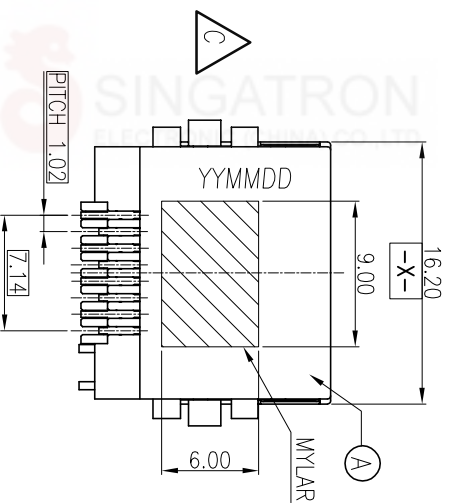
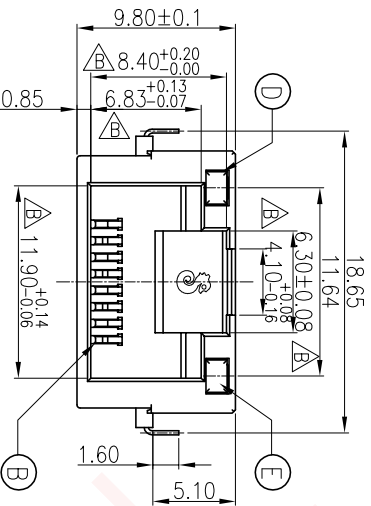
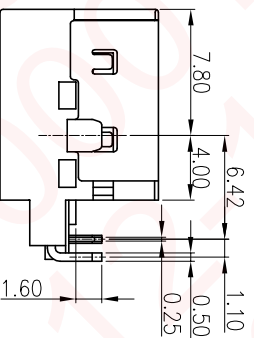
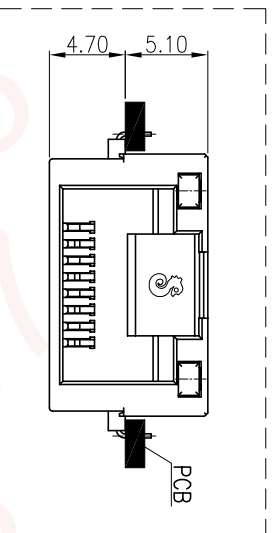

NODE	COLOR	Wavelength
A1(+)	A2(-)	YELLOW 585~597(nm)
B1(+)	B2(-)	GREEN 564.5~576.5 (nm)

NO.	DESCRIPTION	QTY	MATERIAL	PLATING & COLOR
F	Mylar	1		W9.00mm*16.00mm
E	LED	1		GREEN
D	LED	1		YELLOW
C	SHELL	1	Stainless Steel	NI PLATING ALL OVER
B	8P8C CONTACT	8	PHOSPHOR BRONZE	5u" Au ON CONTACT AREA; Matte Sn 120u" ON SOLDER TAIL; ALL OVER NI 50u"MIN.
A	BODY	1	PA10T	UL 94V-0 & BLACK

UNLESS OTHERWISE SPECIFIED TOLERANCES

Singatron Enterprise Co., Ltd.  
信亨企業股份有限公司

TITLE: RJ45 JACK

DWN ALLEN PART NO. 2RJ3030-158411F

CHKD Jones SCALE 4:1 UNIT: mm

APVD BOYE SIZE: A3 SHEET: 1 / 2 REV: C

CUSTOMER COPY

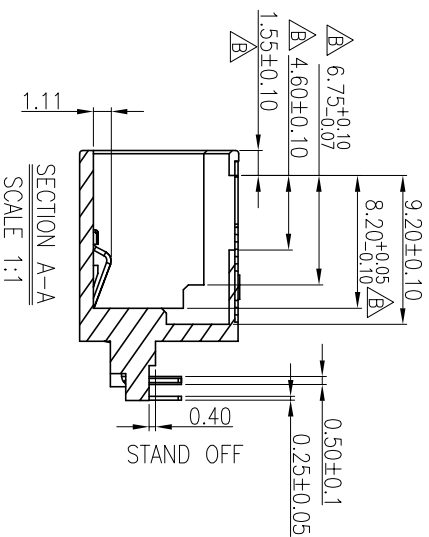
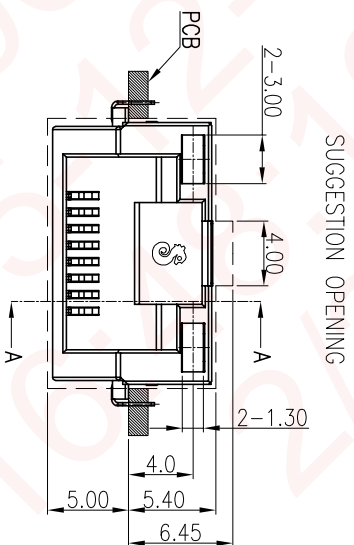
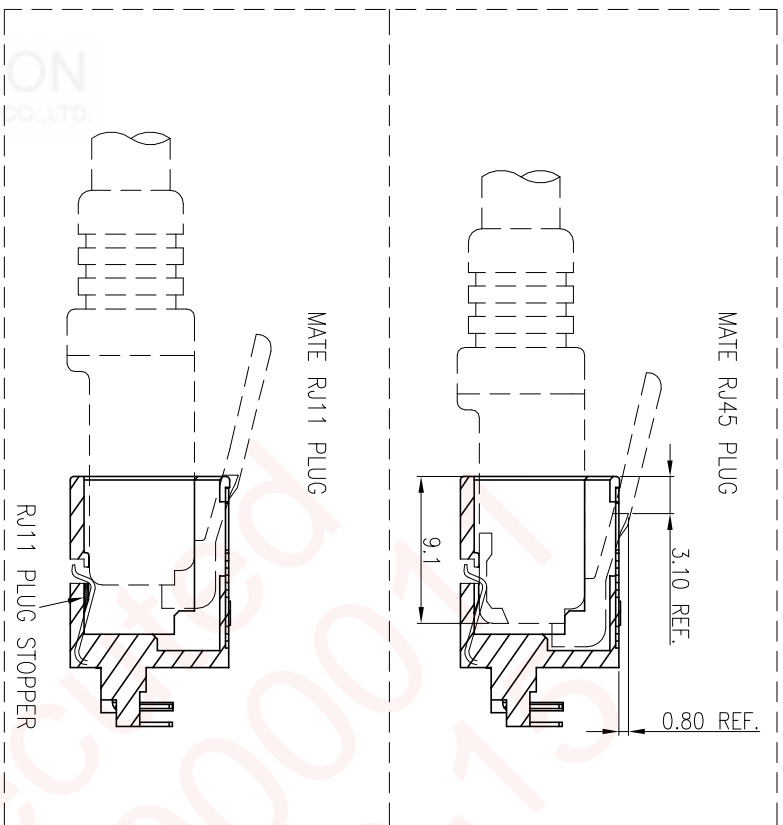

REV.	ECN NO. OR DESCRIPTION	REVISED	DATE
A	PDR NO.:T20927-1A	Sam	2012.12.15
B	ECN NO.:S140136	ALLEN	2014.05.15
C	ECR NO.:S151014-E	ALLEN	2015.10.19

F	Mylar	1		W9.00mm*16.00mm
E	LED	1		GREEN
D	LED	1		YELLOW
C	SHELL	1		Stainless Steel
B	8P8C CONTACT	8		PHOSPHOR BRONZE 5u" Au. ON CONTACT AREA. Mote Sn 120u" ON SOLDER TAIL. ALL OVER NI 50u"MIN.
A	BODY	1	PA10T	UL 94V-0 & BLACK
NO. DESCRIPTION		QTY	MATERIAL	
UNLESS OTHERWISE SPECIFIED TOLERANCES				
DECIMALS:		ANGLES:		
X	:±0.5	X	:±2°	
X,X	:±0.3	X,X	:±1°	
X,XX	:±0.2			
TITLE: RJ45 JACK				
DWN	ALLEN	PART NO.	2RJ3030-158411F	
CHKD	James	SCALE	4:1 UNIT: mm	
APVD	BOYE	SIZE:	A3 SHEET:2 / 2 REV: C	
CUSTOMER COPY				

Singatron Enterprise Co., Ltd.  
信睿企业股份有限公司