

REV.	ECN NO. OR DESCRIPTION	REVISED	DATE
A	PDR NO.:T140728-1A	Allen	2015.02.06
B	EGR NO.:S151014-E	Allen	2015.10.19

SPECIFICATIONS:

- ELECTRICAL CHARACTERISTICS:**
 - 1-1. CURRENT RATING: 1.5A MAX.
 - 1-2. VOLTAGE RATING: 150V MAX.
 - 1-3. CONTACT RESISTANCE : 50mΩ MAX.(INITIAL), 100mΩ MAX.(AFTER LIFE TEST).
 - 1-4. INSULATION RESISTANCE : 100MΩ MIN.
- MECHANICAL CHARACTERISTICS:**
 - 2-1. DURABILITY: 5000 CYCLES.
 - 2-2. INSERTION FORCE: 2.25kg MAX. WITH LATCH DEPRESSED.
 - 2-3. WITHDRAWAL FORCE: 4.5kg MAX. WITH LATCH DEPRESSED.
 - 2-4. OPERATING TEMPERATURE:-30°C ~ +70°C.
- MARKING:** MARK "S" INSIDE OF THE CONNECTOR.
- PACKAGING :** TAPE & REEL.
- TO CONFORM TO SINGATRON HAZARDOUS SUBSTANCE FREE SPEC.**
- HALOGEN FREE PRODUCT IDENTIFICATION**
- HALOGEN FREE PRODUCT IDENTIFICATION**
- ON THE PACKAGING:**
 8. FOR REFLOW SOLDERING LEAD-FREE PROCESS.
 9. PRINTED DATE CODE "YY MM DD" ON TOP OF THE CONNECTOR.



NODE	COLOR	Wavelength
A1(+)	A2(-)	YELLOW 585~597(Nd)
B1(+)	B2(-)	GREEN 564.5~576.5 (Nd)

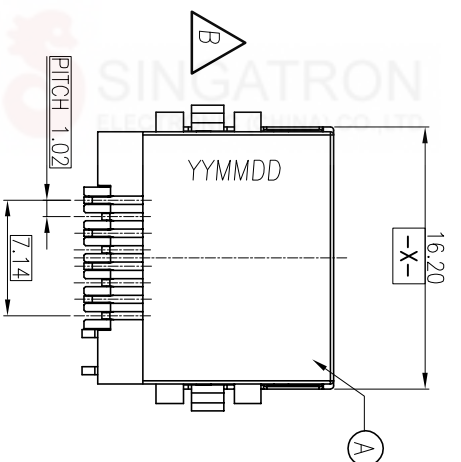
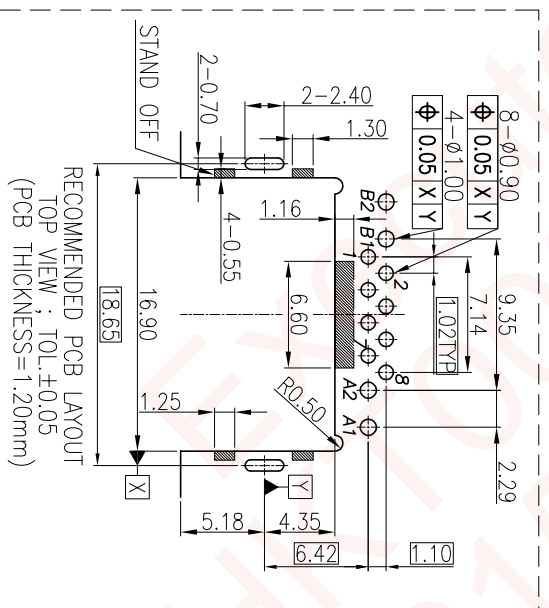
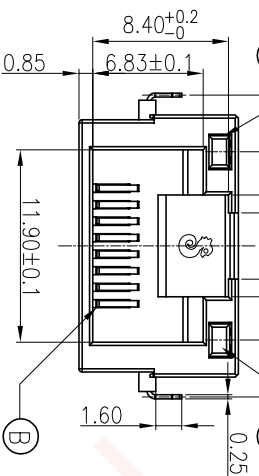
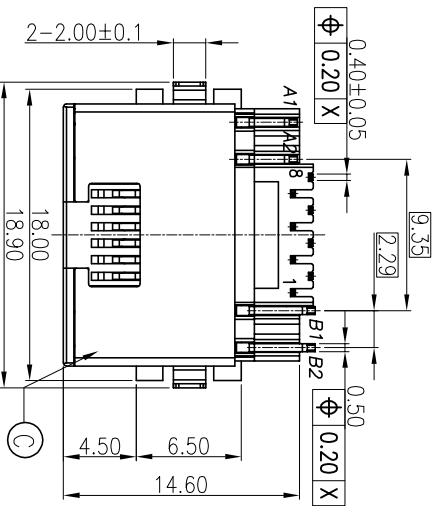
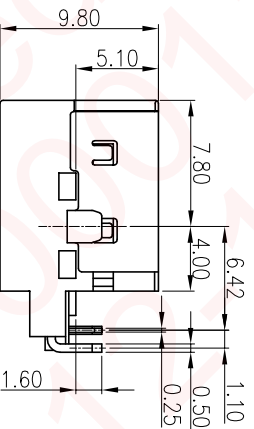
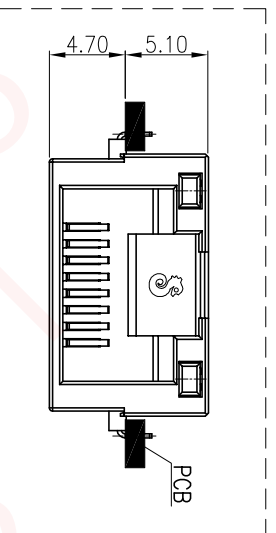

NO.	DESCRIPTION	QTY	MATERIAL	PLATING & COLOR
E	LED	1		GREEN
D	SHELL	1	Stainless Steel	YELLOW
C	8P8C CONTACT	8	PHOSPHOR BRONZE	C/F ON CONTACT AREA: Mate Sn 120u" ON SOLDER TAIL: ALL OVER Ni 50u"MIN.
B	BODY	1	PA10T	UL 94V-0 & BLACK
A	DESCRIPTION			

DECIMALS:	ANGLES:
X : ±0.5	X : ±2°
X.X : ±0.3	X.X : ±1°
X.XX : ±0.2	

TITLE	RJ45 JACK
DWM	Allen
CHKD	James
APVD	Boye

PART NO.	SCALE	UNIT	SHEET:1 / 2	REV. B
2RJ3030-1D8211F	4:1	mm		

Singatron Enterprise Co., Ltd.
信晉企業股份有限公司

CUSTOMER COPY

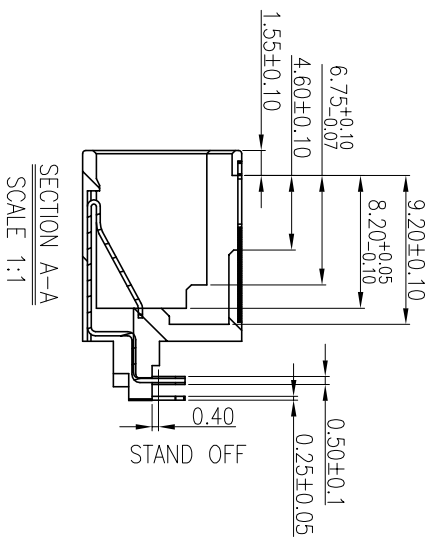
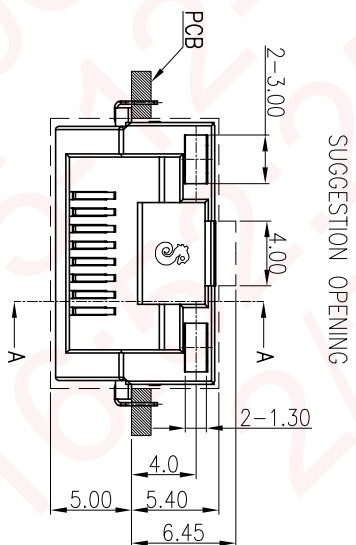
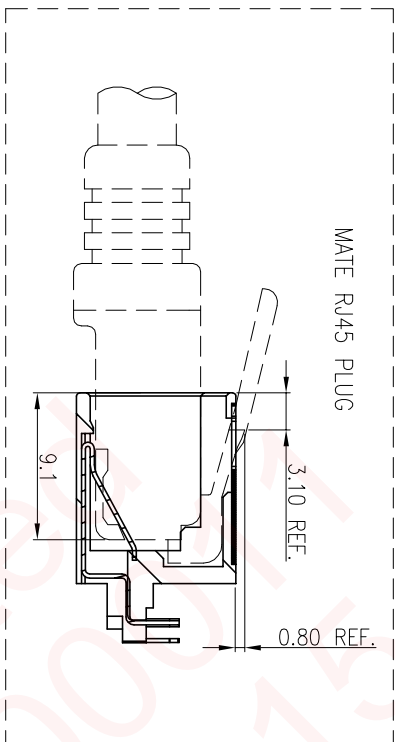

REV.	ECN NO. OR DESCRIPTION	REVISED	DATE
A	PDR NO.:140728-1A	Allen	2015.02.06
B	EGR NO.:S151014-E	Allen	2015.10.19

NO.	DESCRIPTION	QTY	MATERIAL	PLATING & COLOR
UNLESS OTHERWISE SPECIFIED TOLERANCES				
DECIMALS: ANGLES:				
X	±0.5	X	±2°	
X,X	±0.3	X,X	±1°	
X,XX	±0.2			
TITLE: RJ45 JACK				
DWN	Allen	PART NO. 2RJ3030-1D8211F		
CHKD	James	SCALE 4:1	UNIT: mm	
APVD	BoYe	SIZE: A3	SHEET: 2 / 2	REV: B

Singatron Enterprise Co., Ltd.
 信智企業股份有限公司

CUSTOMER COPY