

REV.	ECN NO OR DESCRIPTION	REVISED	DATE
A	PDR NO.T160926-1A	JAMES	2017.03.15

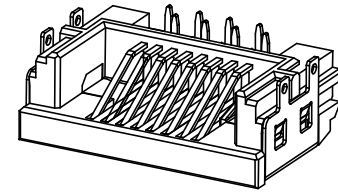
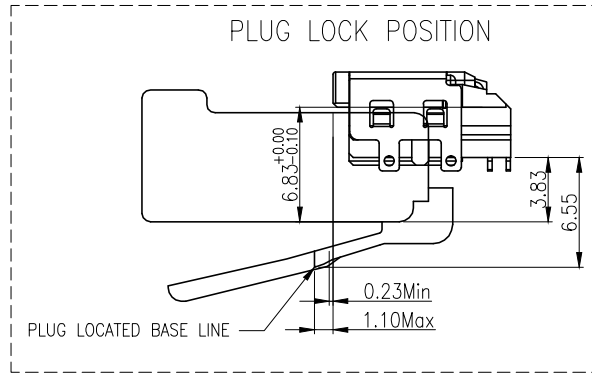
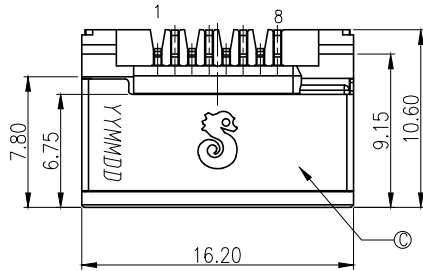

SPECIFICATIONS:

- ELECTRICAL CHARACTERISTICS:
 - CURRENT RATING: 0.5A MAX.
 - VOLTAGE RATING: 150VAC MAX.
 - CONTACT RESISTANCE: 50mΩ MAX.(INITIAL). 100mΩ MAX.(AFTER LIFE TEST).
 - INSULATION RESISTANCE: 100MΩ MIN.
- MECHANICAL CHARACTERISTICS:
 - DURABILITY: 5000 CYCLES.
 - INSERTION FORCE: 2.25Kg MAX. WITH LATCH DEPRESSED.
 - OPERATING TEMPERATURE: -30℃ ~ +70℃.
- MARKING: MARK "S" ON TOP OF THE CONNECTOR.
- PACKAGING: TAPE & REEL.
- TO CONFORM TO SINGATRON HAZARDOUS SUBSTANCE FREE SPEC.
- HALOGEN FREE PRODUCT IDENTIFICATION
MARK ON PRODUCT: ○
- HALOGEN FREE PRODUCT IDENTIFICATION LOGO
ON THE PACKAGING: ●
- FOR REFLOW SOLDERING LEAD-FREE PROCESS.
- PRINTED DATE CODE "YY MM DD" ON TOP OF THE CONNECTOR.

DD: DAY
MM: MONTH
YY: YEAR

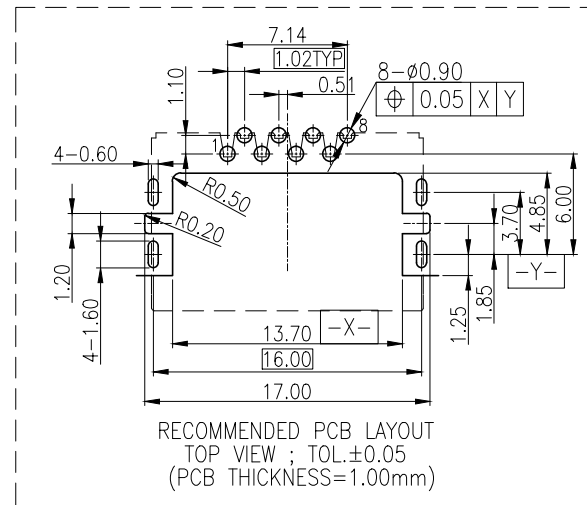
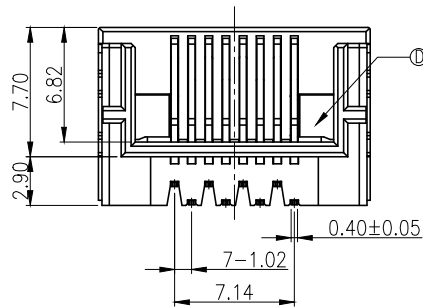
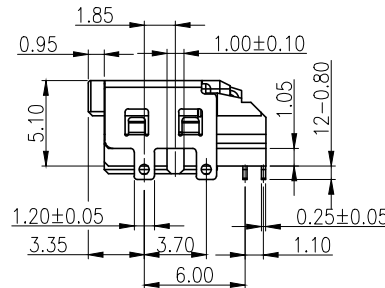
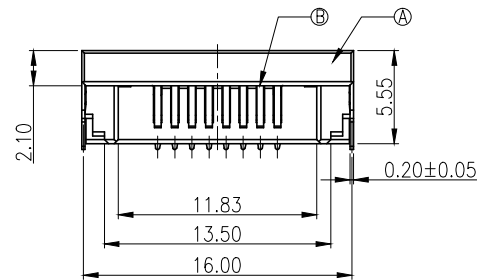

D	RJ11 FOOLPROOF	2	LCP E130i UL94 V-0	BLACK
C	SHELL	1	SUS301 1/2H T:0.2mm	Ni 50u"MIN.
B	8P8C CONTACT	8	C5210-EH T0.25mm	GOLD PLATING ON CONTACT AREA; MATTE Sn 120u" ON SOLDER TAIL; ALL OVER Ni 50u"MIN.
A	BODY	1	LCP E130i UL94 V-0	BLACK
NO	DESCRIPTION	QTY	MATERIAL	PLATING & COLOR

UNLESS OTHERWISE SPECIFIED TOLERANCES		Singatron Enterprise Co., Ltd. 信音企業股份有限公司		
DECIMALS:	ANGLES:	TITLE	RJ45 JACK	
X :±0.50	X :±2°	DWN James	PART NO. 2RJ3049-028211F	
X.X :±0.30	X.X :±1°	CHKD Boye	SCALE 4:1	UNIT: mm
X.XX :±0.20		APVD Boye	SIZE: A3	SHEET: 1 / 1
		REV: A		
CUSTOMER COPY				