

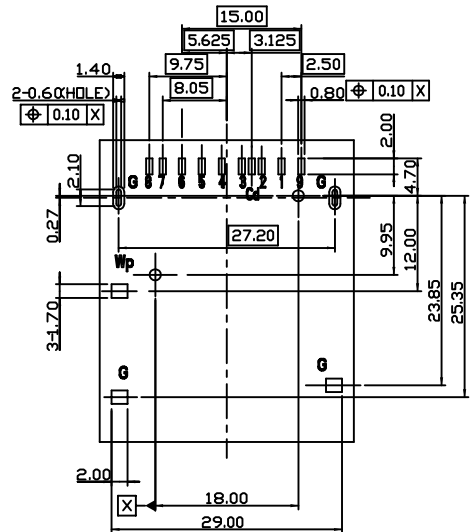

Card detection switch		Write protection switch		
When card is open	When card is lock	When card is open	When card is lock	
		Write protect	Write enable	
OPEN	CLOSE	OPEN	OPEN	CLOSE
Cd VSS1	Cd VSS1	Wp Sc	Wp Sc	Wp Sc

REV.	ECN NO OR DESCRIPTION	REVISED	DATE
A	PDR RELEASE	IVY-C	2016.04.26

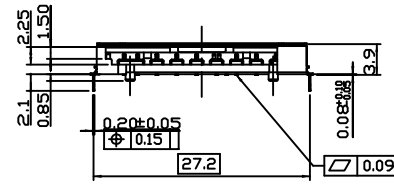
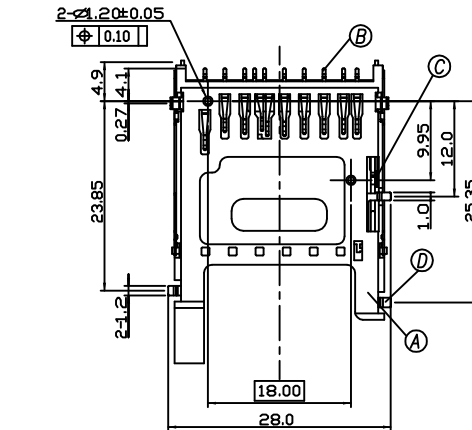
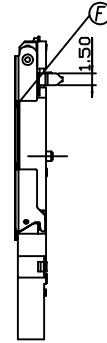
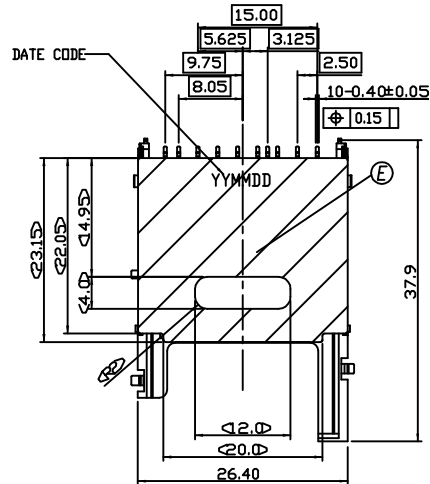

- SPECIFICATIONS:
- TO CONFORM TO THE SINGATRON HAZARDOUS SUBSTANCE FREE SPEC.
 - HALOGEN FREE PRODUCT IDENTIFICATION LABEL ON PACKAGING: 
 - PACKAGE: SEE "2DS1528 SERIES" PACKAGE.
 - FOR REFLOW SOLDERING LEAD-FREE PROCESS.
 - OTHER GENERAL SPEC. TO REFERSEE "2SD1528-000111F" SPEC.



PART NO.
2SD1528-000111F

- SUFFIX: HALOGEN FREE
- PACKAGE
- 1: TAPE & REEL
- HOUSING COLOR
- 1: BLACK
- CONTACT PLATING
- 1: GOLD FLASH ON CONTACT AREA AND GOLD FLASH ON SOLDER AREA
- NICKEL UNDER PLATING OVERALL

PIN NO.	PIN ASSIGNMENT	PIN NO.	PIN ASSIGNMENT
1	DAT3/CS/CD	8	DAT1
2	CMD	9	DAT2
3	VSS1	Wp	WRITE PROTECTION
4	VDD	Cd	CARD DETECTION
5	CLK	Sc	COMMON PIN
6	VSS2	G	GROUND
7	DAT0		

RECOMMEND PC BOARD LAYOUT
GENERAL TOLERANCE: ±0.05mm

NO	DESCRIPTION	QTY	MATERIAL	PLATING & COLOR
F	SHELL	1	STAINLESS	
E	MYLAR	1		BLACK
D	CARD DETECTION PIN	1	PHOSPHOR BRONZE	GOLD FLASH ON SOLDER AREA
C	WRITE PROTECTION PIN	1	PHOSPHOR BRONZE	GOLD FLASH ON CONTACT AREA
B	CONTACT	9	PHOSPHOR BRONZE	SEE PART NO.
A	HOUSING	1	LCP UL94V-0	BLACK

UNLESS OTHERWISE SPECIFIED TOLERANCES		 Singatron Enterprise Co., Ltd.  信音企業股份有限公司	
DECIMALS:	ANGLES:	TITLE	SD CONNECTOR
X : ±0.5	X : ±2°	DWN	NY-C 2016.04.26 PART NO. 2SD1528-000111F
X.X : ±0.3	X.X : ±1°	CHKD	ANCELA2016.04.26 SCALE: N/A UNIT: mm
X.XX : ±0.2		APVD	ANCELA2016.04.26 SIZE: A3 SHEET: 1 OF 1 REV: A
CUSTOMER COPY			