

DATE CODE: \_\_\_\_\_

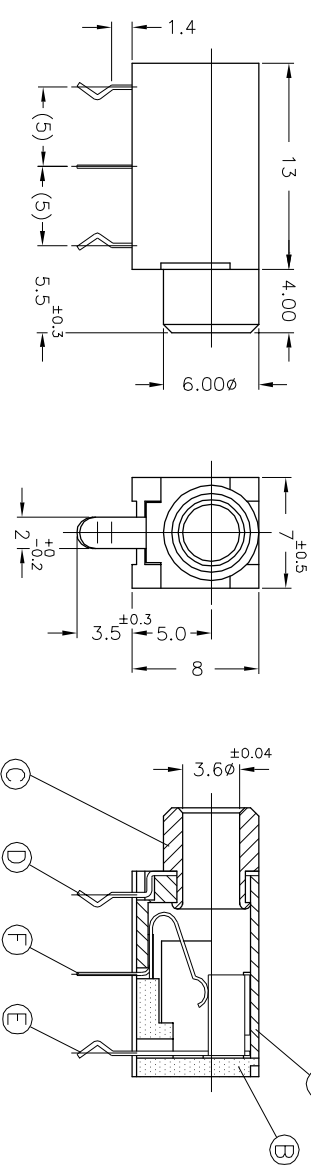

- SPECIFICATION:
- CONTACT RESISTANCE: 30 mΩ MAX.
  - INSULATION RESISTANCE: 100 MΩ MIN. AT 250V DC.
  - DIELECTRIC STRENGTH: 250V AC 1 MINUTE.
  - LIFE TEST:  
JACK SHALL WITHSTAND 5000 CYCLES OF INSERTION AND WITHDRAWAL WITH TESTING PLUG, AFTER TEST THE CONTACT RESISTANCE SHALL NOT EXCEED 0.1Ω
  - MEASURING CONDITION:  
TEMPERATURE: FROM 5°C TO 35°C  
RELATIVE HUMIDITY: FROM 40% TO 85%
  - ELECTRICAL CIRCUIT:

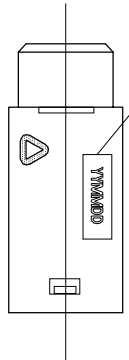
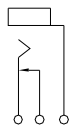

- INSERTION FORCE: 0.4Kg~1.6Kg.
- WITHDRAWAL FORCE: 0.4Kg~1.6Kg.
- SOLDERING CONDITION: WAVE SOLDERING.
- TO CONFORM TO THE "SE-01-001" & "THE EUROPEAN RESTRICTIONS-ON HAZARDOUS SUBSTANCES (ROHS) DIRECTIVE"
- GREEN PRODUCT IDENTIFICATION MARK IN JACK:
- GREEN PRODUCT IDENTIFICATION LABEL IN PACKING:
- PRINTED DATE CODE "YINMIND"

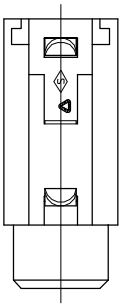
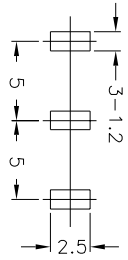
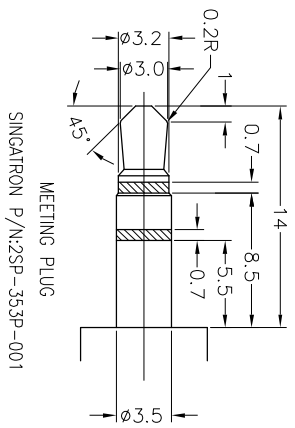
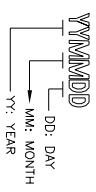

F	TERMINAL	1	COPPER ALLOY 0.2T	SILVER PLATING
E	SHUNT TERMINAL	1	BRASS 0.3t	SILVER PLATING
D	EARTH TERMINAL	1	BRASS 0.3t	SILVER PLATING
C	METAL	1	BRASS	NICKEL PLATING
B	COVER	1	PBT UL 94V-0	BLACK COLOR
A	BODY	1	PBT UL 94V-0	BLACK COLOR
NO	DESCRIPTION	QTY	MATERIAL	PLATING & COLOR
UNLESS OTHERWISE SPECIFIED TOLERANCES				
Singatron Enterprise Co., Ltd. <b>信音企業股份有限公司</b>				
TITLE		3.5φ AUDIO JACK		
DECMALS:	ANGLES:			
X : ±0.5	X : ±2°			
X.X : ±0.3	X.X : ±1°			
X.XX : ±0.2				
DWN Shihong		PART NO: 2SJ-03702N23		
CHKD Bruce		SCALEN/A UNIT: mm		
APVD Liao		SIZE: A3 SHEET: 10F1 REV: A		
<b>CUSTOMER COPY</b>				

REV.	ECH NO OR DESCRIPTION	REVISED	DATE
A	ECH NO:202308-C20 EOL RESTART	Shihong	2023.10.10