

REV.	ECN NO OR DESCRIPTION	REVISED	DATE
A	INITIAL RELEASE	孫一中	2009.03.12
B	C100196	Kim	2010.05.06
C	ECN NO:C100404 Add Dimension	LONGJIANG	2010.10.06

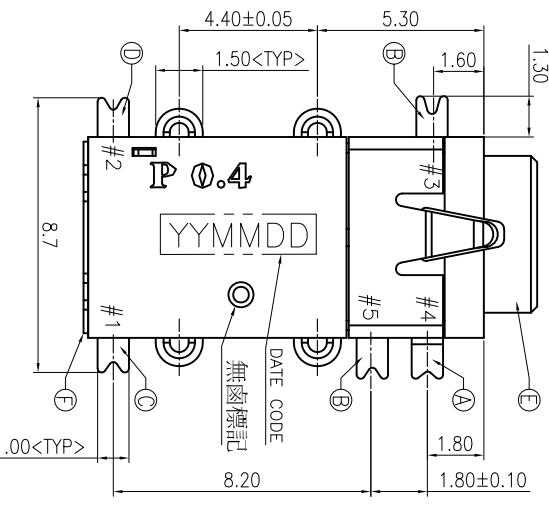

- SPECIFICATIONS:
- ELECTRICAL CHARACTERISTICS:
    - 1-1 WORKING VOLTAGE: 36V MAX.
    - 1-2 CONTACT RESISTANCE: 30mΩ MAX(INITIAL)
  - MATING FORCE 3kg Max UNMATING FORCE 0.3kg Min.
  - LIFE TEST: 10,000 CYCLES MIN.
  - PACKING: TAPE & REEL
  - TO CONFORM TO THE SINGATRON HSF SPECIFICATION.
  - HALOGEN FREE PRODUCT IDENTIFICATION MARK:
  - HALOGEN FREE PRODUCT IDENTIFICATION LABEL ON PACKAGING:
  - FOR LEAD-FREE PROCESS.
  - SOLDER HEAT RESISTANCE REFLOW SOLDERING 260°C 10SECS.
  - PRINTED DATE CODE "YYMMDD" ON TOP OF CONNECTOR.

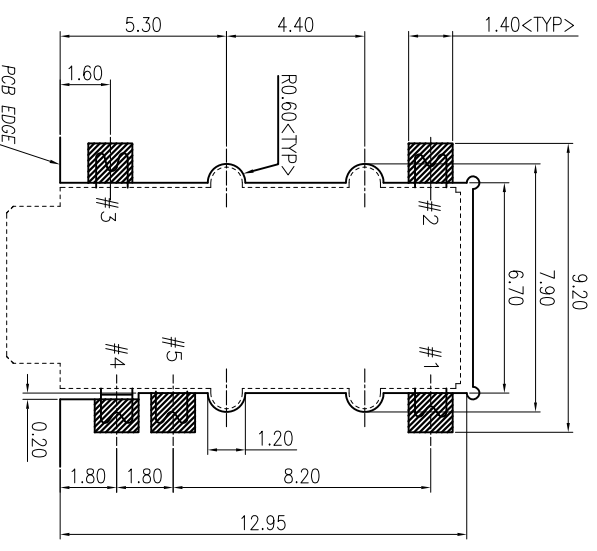
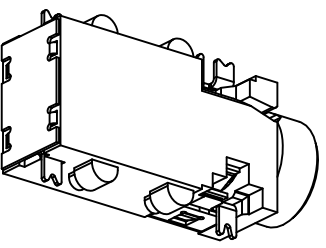
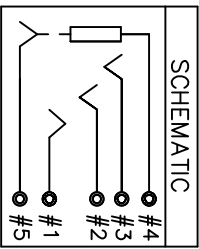
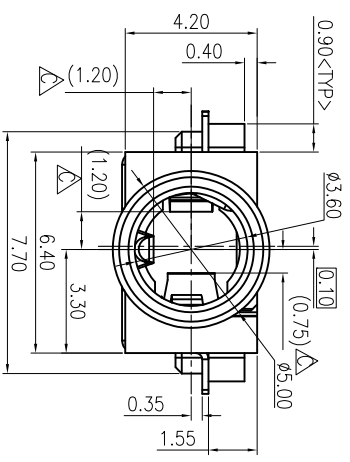
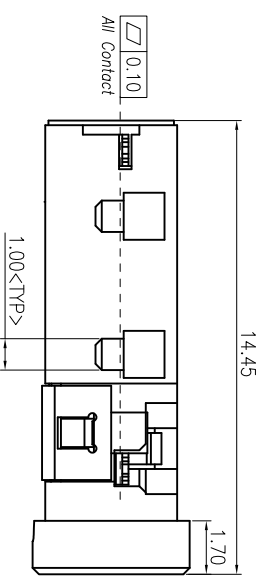
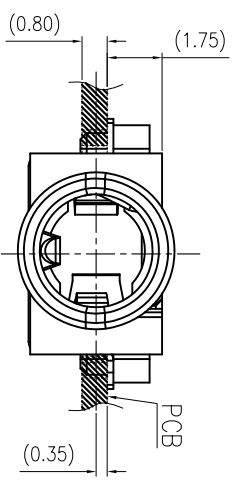
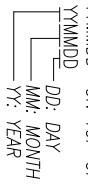

RECOMMENDED PCB LAYOUT  
TOP VIEW (TOLERANCE:±0.05)

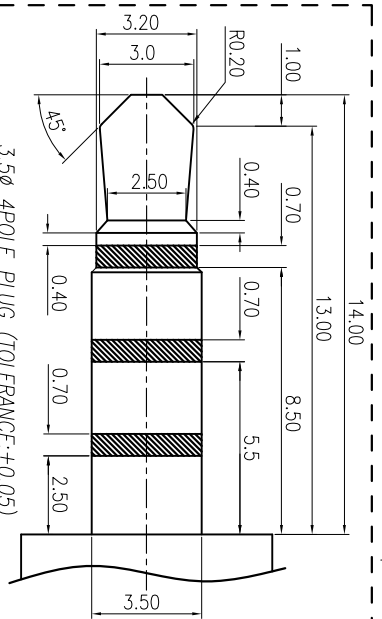

NO	DESCRIPTION	QTY	MATERIAL	PLATING & COLOR
F	COVER	1	SUS	
E	BODY	1	THERMOPLASTIC HIGH TEMP	BLACK COLOR
D	RING SPRING A	1	COPPER ALLOY 0.2t	Ni40~120u"/Au1~3u"
C	TIP SPRING	1	COPPER ALLOY 0.2t	Ni40~120u"/Au1~3u"
B	RING SPRING B	2	COPPER ALLOY 0.2t	Ni40~120u"/Au1~3u"
A	EARTH	1	COPPER ALLOY 0.2t	Ni40~120u"/Au1~3u"
NO	DESCRIPTION	QTY	MATERIAL	PLATING & COLOR

UNLESS OTHERWISE SPECIFIED TOLERANCES

Singatron Enterprise Co., Ltd.  
信音企業股份有限公司

TITLE: 3.5φ PHONE JACK

DWN: 11.01.03  
CHKD: 11.01.03  
APVD: 11.01.03

PART NO. 2SJ2271-005111  
SCALE 6:1  
SIZE: A3  
SHEET: 10F1

DECIMALS:	ANGLES:
X : ±0.5	X : ±2°
X.X : ±0.3	X.X : ±1'
X.XX : ±0.2	

REV.	DATE	BY	CHKD
1	11.01.03		

CUSTOMER COPY