

REV.	ECN NO OR DESCRIPTION	REVISED	DATE
A	PRODUCT RELEASE	Kermit	2014.06.06
B	ECN NO.:C150027 UPDATE DRAWING	ZLS	2015.03.06
C	ECN NO.:S161108-P	YUREN	2017.7.26

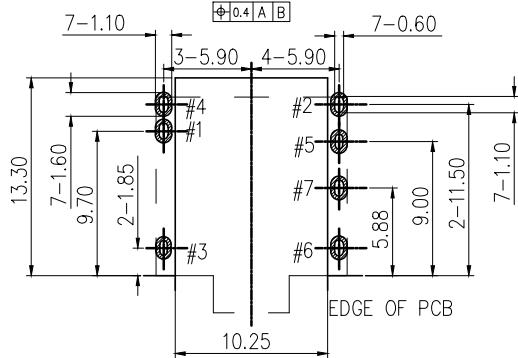

RECOMMENDED P.C.B. LAYOUT T=1.00  
TOP VIEW (TOLRANCE: ±0.05)

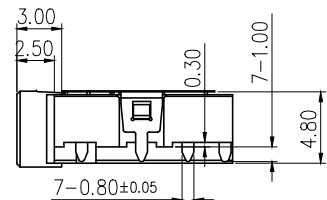
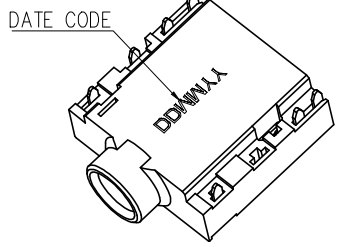
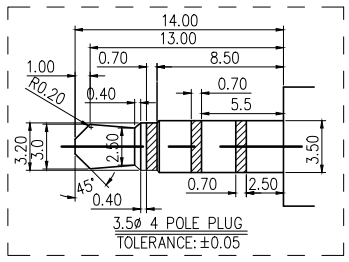
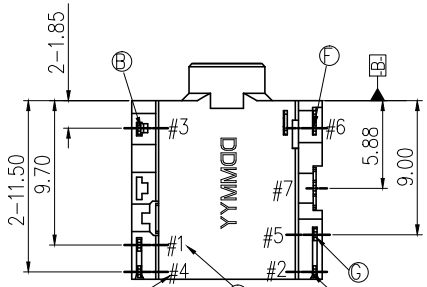
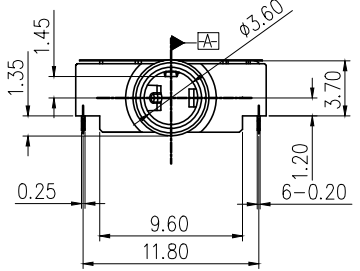
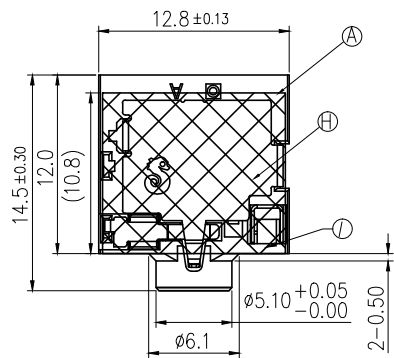
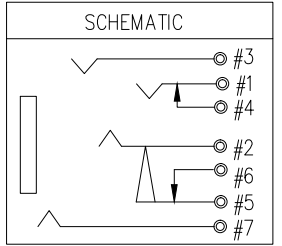

- SPECIFICATIONS:
- ELECTRICAL CHARACTERISTICS:
    - RATING: 36V 1A
    - CONTACT RESISTANCE: 50mΩ MAX.
    - DIELECTRIC WITHSTANDING VOLTAGE: 500V AC FOR ONE MINUTE.
    - INSULATION RESISTANCE: 100MΩ MIN. MEASURED BY 500 VDC
  - MECHANICAL CHARACTERISTICS:
    - INSERTION FORCE : 0.4~3.0 KGF
    - WITHDRAWAL FORCE : 0.3~2.0 KGF
  - LIFE TEST: 5,000 CYCLES .
  - OTHER GENERAL SPEC. TO REFER "2SJ2285 SERIES SPEC".
  - TO CONFORM TO THE SINGATRON HAZARDOUS SUBSTANCE FREE SPEC.
  - HALOGEN PRODUCT IDENTIFICATION MARK ON JACK:
  - HALOGEN PRODUCT IDENTIFICATION LABEL ON PACKAGING:
  - FOR REFLOW SOLDERING LEAD-FREE PROCESS.
  - PACKAGING: TAPE&REEL.
  - DATE CODE: YYMMDD
    - Day
    - Month
    - Year

I	MYLAR	1	KAPTON T=0.075MM	YELLOW TRANSPARENT
H	SHELL	1	PHOSPHOR BRONZE T=0.2MM	NI 60u"Min PLATING
G	TRANSFER TERMINAL	1	PHOSPHOR BRONZE T=0.2MM	GOLD FLASH ON CONTACT AREA AND SOLDER TAIL. AN OVER 50u"Ni MODEL PLATED
F	BRAKE TERMINAL	1	PHOSPHOR BRONZE T=0.2MM	GOLD FLASH ON CONTACT AREA AND SOLDER TAIL. AN OVER 50u"Ni MODEL PLATED
E	RING	1	PHOSPHOR BRONZE T=0.2MM	GOLD FLASH ON CONTACT AREA AND SOLDER TAIL. AN OVER 50u"Ni MODEL PLATED
D	SHUNT	1	BRASS T=0.20MM	GOLD FLASH ON CONTACT AREA AND SOLDER TAIL. AN OVER 50u"Ni MODEL PLATED
C	TIP	1	PHOSPHOR BRONZE T=0.25MM	GOLD FLASH ON CONTACT AREA AND SOLDER TAIL. AN OVER 50u"Ni MODEL PLATED
B	EARTH	1	PHOSPHOR BRONZE T=0.2MM	GOLD FLASH ON CONTACT AREA AND SOLDER TAIL. AN OVER 50u"Ni MODEL PLATED
A	BODY	1	PPS+45%GF A305M45B UL94V-0	BLACK
NO	DESCRIPTION	QTY	MATERIAL	PLATING & COLOR

UNLESS OTHERWISE SPECIFIED TOLERANCES		Singatron Enterprise Co., Ltd. 信音企業股份有限公司	
DECIMALS:	ANGLES:	TITLE: 3.5φ PHONE JACK	
X :±0.5	X :±2°	DWN	YUREN PART NO. 2SJ2284-105393F
X.X :±0.3	X.X :±1°	CHKD	CERRY SCALE 1:1 UNIT: mm
X.XX :±0.2		APVD	LIAO SIZE: A3 SHEET: 10F1 REV: C
CUSTOMER COPY			