

REV.	ECN NO OR DESCRIPTION	REVISED	DATE
B	ECN NO: C120036 MODIFY MYLAR	BILLY	2012.02.20
C	ECN NO: C120297 ADDING SIZE	ZLS	2012.10.17
D	ECN NO: C140032 UPDATE DATE CODE	ZLS	2014.7.11

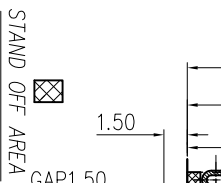
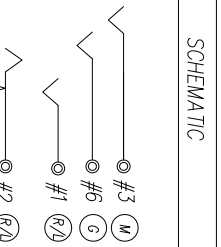
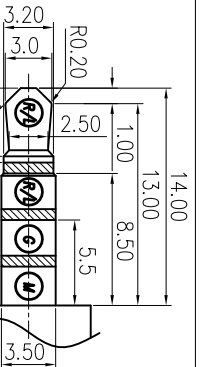
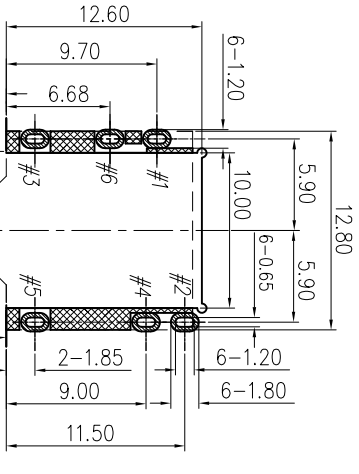
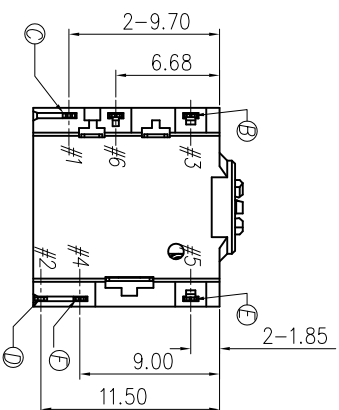
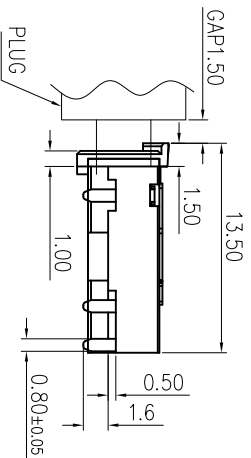
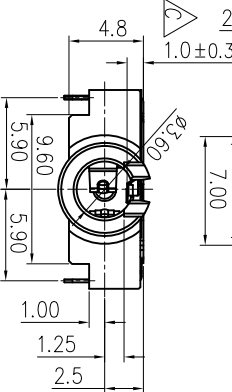
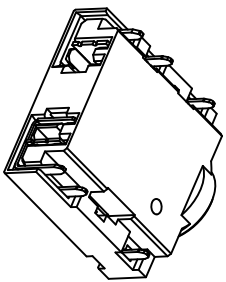
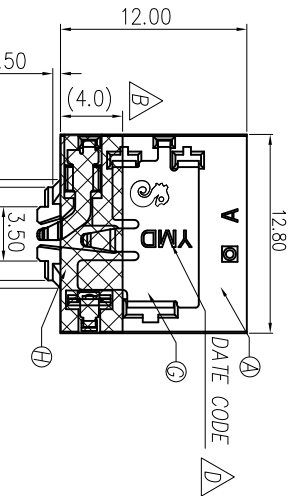

RECOMMENDED P.C.B. LAYOUT T=1.00
TOP VIEW (TOLERANCE: ±0.05)

SPECIFICATIONS:

- ELECTRICAL CHARACTERISTICS:**
 - RATING: 12V, 1A.
 - CONTACT RESISTANCE: 50mΩ MAX.
 - DIELECTRIC WITHSTANDING VOLTAGE: 500V AC FOR ONE MINUTE.
 - INSULATION RESISTANCE: 100MΩ MIN. MEASURED BY 500 VDC.
- MECHANICAL CHARACTERISTICS:**
 - INSERTION FORCE : 0.4~3.0 KGF
 - WITHDRAWAL FORCE : 0.3~2.0 KGF
- LIFE TEST: 5,000 CYCLES MIN.
- OTHER GENERAL SPEC. TO REFER "2SJ2285 SERIES SPEC."
- TO CONFORM TO THE SINGATRON HAZARDOUS SUBSTANCE FREE SPEC.
- HALOGEN FREE PRODUCT IDENTIFICATION MARK ON JACK: ◎
- HALOGEN FREE PRODUCT IDENTIFICATION LABEL ON PACKAGING: ◎
- FOR REFLOW SOLDERING LEAD-FREE PROCESS.
- PACKAGING: TAPE&REEL.



NO	DESCRIPTION	QTY	MATERIAL	PLATING & COLOR
H	MYLAR	1	MYLAR 0.075T	YELLOW
G	SHIELD	1	COPPER ALLOY 0.20T	Sold flush on contact area all over Nickel Plated
F	TRANSFER TERMINAL	1	COPPER ALLOY 0.20T	Sold flush on contact area and Solder fill/all over Nickel Plated
E	MAKE TERMINAL	1	COPPER ALLOY 0.20T	GOLD FLASH
D	RING	1	COPPER ALLOY 0.20T	Sold flush on contact area and Solder fill/all over Nickel Plated
C	TIP	1	COPPER ALLOY 0.25T	Solder fill/all over Nickel Plated
B	EARTH	1	COPPER ALLOY 0.20T	GOLD FLASH
A	BODY	1	HIGH TEMP THERMOPLASTIC UL 94V-0	BLACK

UNLESS OTHERWISE SPECIFIED TOLERANCES

Singatron Enterprise Co., Ltd.
信登企業股份有限公司

TITLE: 3.5Ø PHONE JACK

DWN ZLS 14/7/21 PART NO. 2SJ2326-014111F

CHKD BILLY 14/7/21 SCALE 3:1 UNIT: mm

APVD Liao 14/7/21 SIZE: A3 SHEET: 10F1 REV: D

CUSTOMER COPY