

REV.	ECN NO OR DESCRIPTION	REVISED	DATE
A	PRODUCT RELEASE	BILLY	2012.01.28
B	ECN NO:C120022 ADD DIM	BILLY	2012.03.08

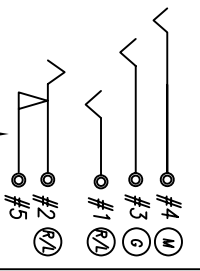
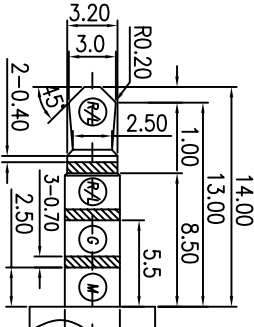
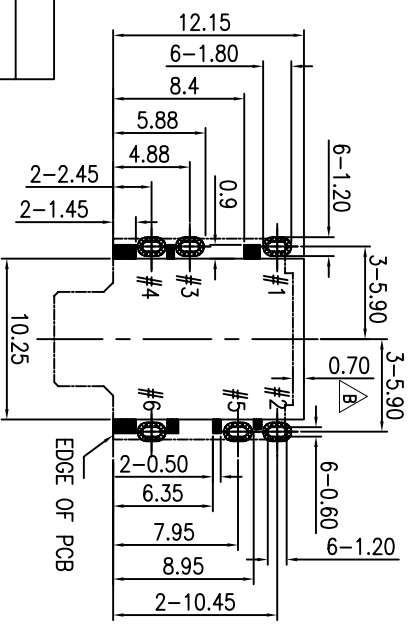
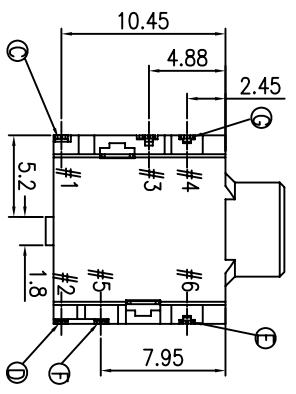
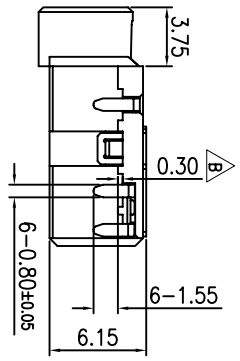
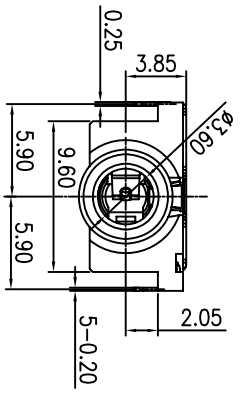
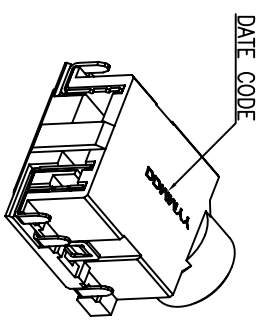
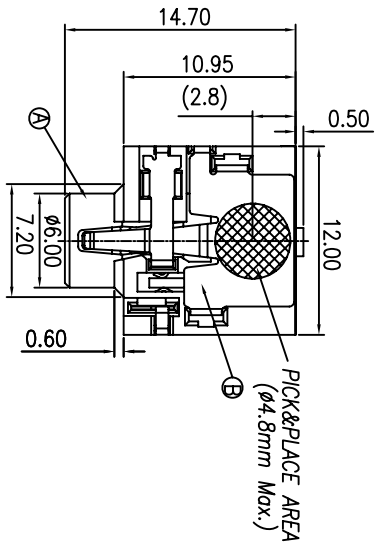

RECOMMENDED P.C.B. LAYOUT T=1.20
 TOP VIEW (TOLERANCE: ±0.05)
 STAND OFF AREA

SPECIFICATIONS:

- ELECTRICAL CHARACTERISTICS:
 - RATING: 36V 1A
 - CONTACT RESISTANCE: 50m Ω MAX.
 - DIELECTRIC WITHSTANDING VOLTAGE: 500V AC FOR ONE MINUTE.
 - INSULATION RESISTANCE: 100MΩ MIN. MEASURED BY 500 VDC
- MECHANICAL CHARACTERISTICS:
 - INSERTION FORCE : 0.4~3.0 KGF
 - WITHDRAWAL FORCE : 0.4~3.0 KGF
- LIFE TEST: 5,000 CYCLES MIN.
- OTHER GENERAL SPEC. TO REFER "2SJ2311 SERIES SPEC".
- TO CONFORM TO THE SINGATON HAZARDOUS SUBSTANCE FREE SPEC.
- HALOGEN FREE PRODUCT IDENTIFICATION MARK ON JACK: ○
- HALOGEN FREE PRODUCT IDENTIFICATION LABEL ON PACKAGING:
- FOR REFLOW SOLDERING LEAD-FREE PROCESS.
- PACKAGING: TAPE & REEL.



G	EARTH	1	COPPER ALLOY 0.20T	
F	TRANSFER TERMINAL	1	COPPER ALLOY 0.20T	
E	MAKE TERMINAL	1	COPPER ALLOY 0.20T	Gold Finish on contact and solder tabs, Silver Nickel Plated.
D	RING	1	COPPER ALLOY 0.20T	
C	TIP	1	COPPER ALLOY 0.25T	
B	SHIELD	1	COPPER ALLOY 0.20T	NI PLATED
A	BODY	1	HIGH TEMP.THERMOPLASTIC UL 94V-0	BLACK
NO	DESCRIPTION	QTY	MATERIAL	PLATING & COLOR
UNLESS OTHERWISE SPECIFIED TOLERANCES				
Singaton Enterprise Co., Ltd. 信音企業股份有限公司				
TITLE: 3.50 PHONE JACK				
DWN: BILLY 20120308 PART NO. 2SJ2352-000131F				
CHKD: ZIZ 20120308 SCALE 1:1 UNIT: mm				
APVD: Liao 20120308 SIZE: A3 SHEET: 10F1 REV: B				
CUSTOMER COPY				

DECIMALS: ANGLES:
 X : ±0.5 X : ±2°
 X.X : ±0.3 X.X : ±1'
 X.XX : ±0.2