

REV.	ECN NO OR DESCRIPTION	REVISED	DATE
A	PDR RELEASE	IVY-C	2016.07.25

SPECIFICATIONS:

- ELECTRICAL CHARACTERISTICS:
  - CURRENT RATING: 1 AMP.
  - VOLTAGE RATING: 12V.
  - CONTACT RESISTANCE: 30mΩ MAX.(INITIAL)
  - INSULATION RESISTANCE: 100MΩ MIN. @ 500V DC.
  - DIELECTRIC WITHSTANDING VOLTAGE: 500V AC FOR 1 MINUTE.
- MECHANICAL CHARACTERISTICS:
  - INSERTION FORCE: 0.3~3.0 kgf.
  - WITHDRAWAL FORCE: 0.3~3.0 kgf.
- LIFE TEST: 5,000 CYCLES.
- OTHER GENERAL SPEC. TO REFER "2SJ2428-001231F SPEC".
- TO CONFORM TO THE SINGATRON HAZARDOUS SUBSTANCE FREE SPEC.
- HALOGEN FREE PRODUCT IDENTIFICATION LABEL ON PACKAGING: 
- PACKAGE: SEE "2SJ2428-001231F" PACKAGE.
- FOR REFLOW SOLDERING LEAD-FREE PROCESS.
- OVERLOAD FORCE: 2.5kg.

PART NO.

2SJ2428-001231F

SUFFIX: HALOGEN FREE

PACKAGE

1: TAPE & REEL

HOUSING COLOR  
3: ORANGE(1375C)

CONTACT PLATING  
2: GOLD FLASH ON CONTACT AREA,  
GOLD FLASH ON SOLDER AREA  
50"u NICKEL UNDERPLATED OVERALL.

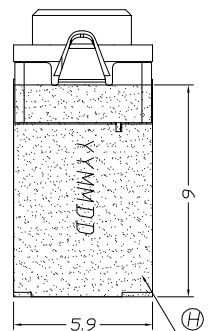
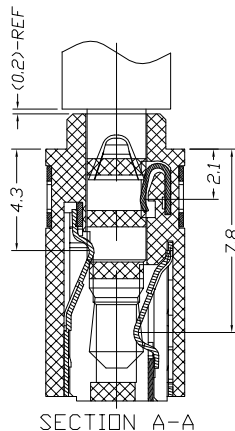
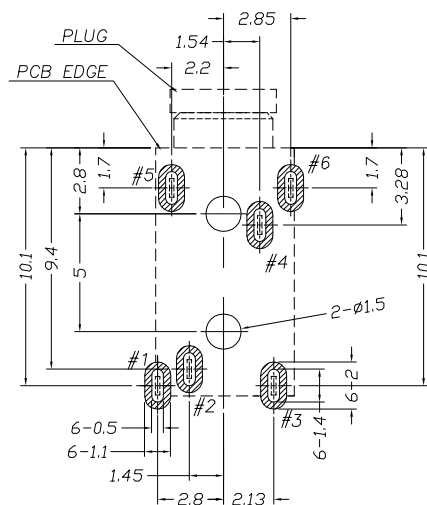
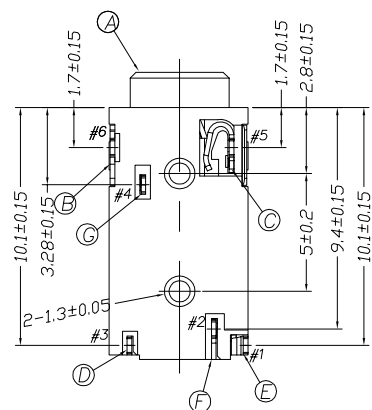
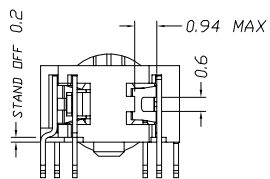
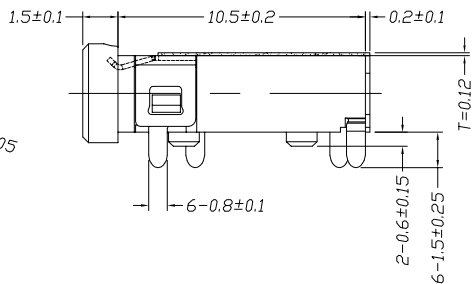
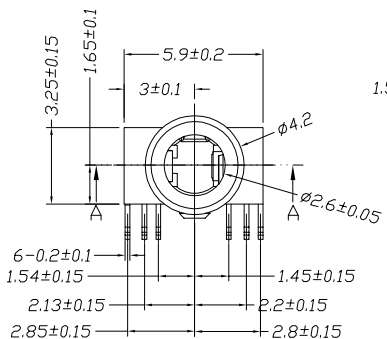

NO	DESCRIPTION	QTY	MATERIAL	PLATING & COLOR
H	MYLAY	1	POLYIMIDE TAPE(9x5.9x0.12)	YELLOW
G	SHUNT TERMINAL-2	1	C5191	SEE PART NO.
F	SHUNT TERMINAL-1	1	C5191	SEE PART NO.
E	TIP SPRING	1	C5191	SEE PART NO.
D	RING SPRING-A	1	C5191	SEE PART NO.
C	RING SPRING-B	1	C5191	SEE PART NO.
B	EARTH TERMINAL	1	C5191	SEE PART NO.
A	HOUSING	1	PAGT UL 94V-0	SEE PART NO.

UNLESS OTHERWISE SPECIFIED TOLERANCES

 Singatron Enterprise Co., Ltd.  
信音企業股份有限公司

DECIMALS:	ANGLES:	TITLE	2.5Ø MINIATURE JACK, R/A, DIP TYPE	
X :±0.5	X :±2°	DWN	IVY-C 2016.07.25	<b>PART NO. 2SJ2428-001231F</b>
X.X :±0.3	X.X :±1°	CHKD	ANGELA2016.07.25	SCALE 4:1 UNIT: mm
X.XX :±0.2		APVD	ANGELA2016.07.25	SIZE: A3 SHEET:1 OF 1 <b>REV: A</b>

CUSTOMER COPY

T:1.6 Dimensions of PC board holes  
Tolerance : ±0.05(Printed-top view)

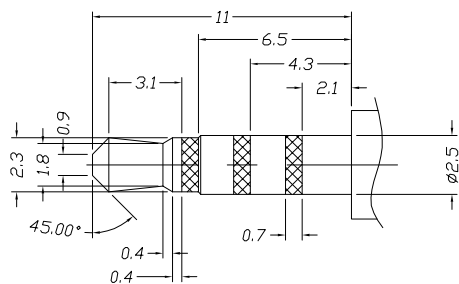

Ø2.5 4POLE PLUG(±0.05)

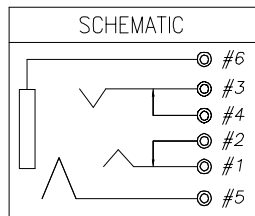

DATE CODE

