

REV.	ECN NO OR DESCRIPTION	REVISED	DATE
A	PDR NO: T120110-1A	Aaron	2012.2.15
B	ECN NO: S140845	ANDY	2014.12.18
C	ECN NO: S150443-C	YULIN	2015.05.22

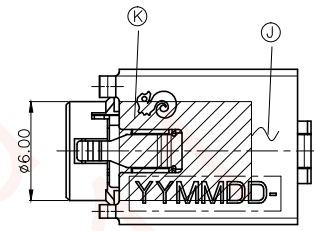

- SPECIFICATIONS:
- INSULATION RESISTANCE BETWEEN ANY ADJACENT OPEN CIRCUIT TERMINAL SHELL NOT BE LESS THAN 100MΩ MEASURED BY 500 VDC MEGGER.
 - CONTACT RESISTANCE: 50mΩ MAX.
 - INSULATION VOLTAGE WITHSTAND: 500V AC FOR ONE MINUTE.
 - UNLESS OTHERWISE SPECIFIED, TEST IS TO BE MADE AT 5-35°C IN TEMPERATURE AND 45-85% IN HUMIDITY. BUT, IF ANY VAGUE DATA IS OCCURED ON TEST RESULT, ANOTHER TEST SHALL BE MADE AT 20°C±2°C IN TEMP., 60-70% IN HUMIDITY.
 - LIFE TEST: 5,000 CYCLES MIN.
 - INSERTION FORCE: 0.4 - 3Kg.
 - WITHDRAWAL FORCE: 0.3 - 2Kg.
 - AFTER LIFE TEST, CONTACT RESISTANCE: 60mΩ MAX.
 - AFTER HUMIDITY TEST, INSULATION RESISTANCE: 50MΩ MIN.
 - MARKING: MARK "S" ON TOP OF CONNECTOR.
 - PACKAGING : TAPE & REEL.
 - TO CONFORM TO SINGATRON HAZARDOUS SUBSTANCE FREE SPEC.
 - HALOGEN FREE PRODUCT IDENTIFICATION MARK ON JACK:
 - HALOGEN FREE PRODUCT IDENTIFICATION LABEL ON PACKAGING:

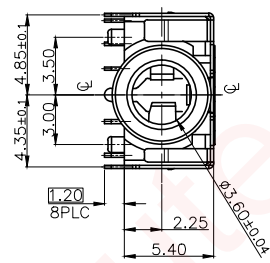
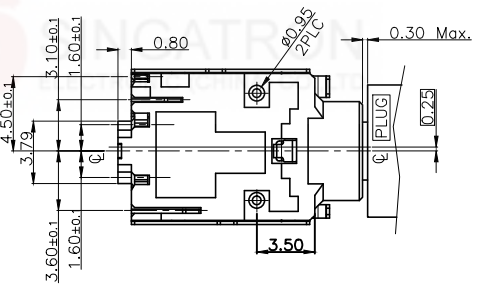
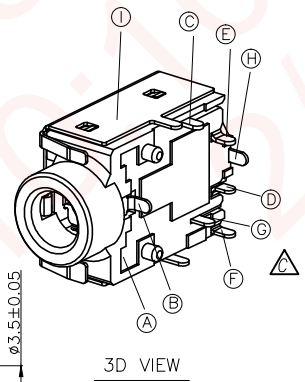
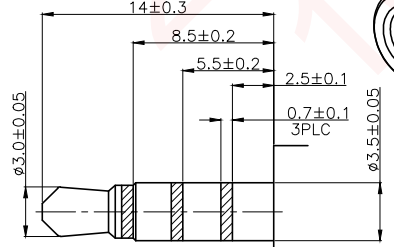
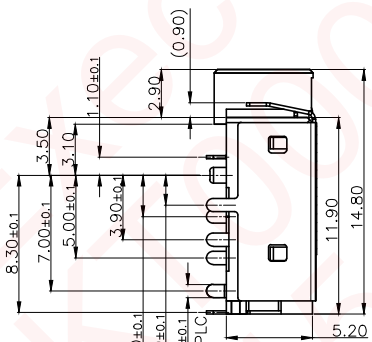
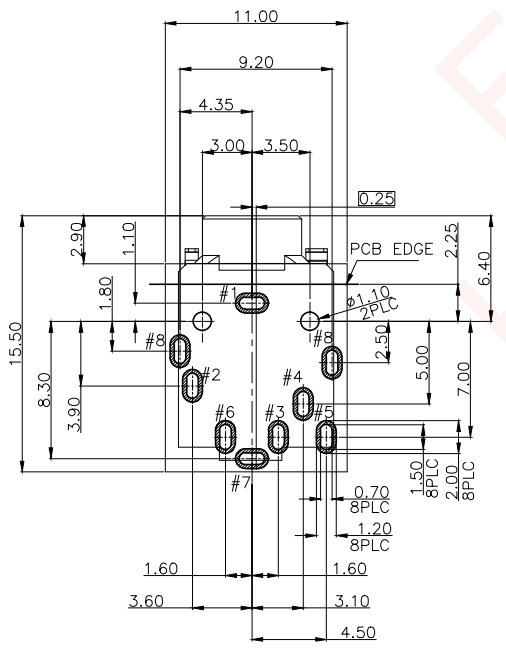
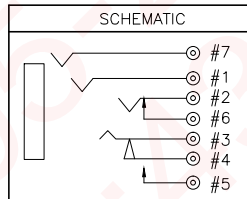

K	MYLAR	1	KAPTON	YELLOW.								
J	MYLAR	1	KAPTON	YELLOW.								
I	SHIELDING	1	PHOSPHOR BRONZE 0.2t	Ni 60u" MIN.								
H	EARTH-B	1	PHOSPHOR BRONZE 0.2t									
G	TRANSFER TERMINAL	1	PHOSPHOR BRONZE 0.2t	GOLD FLASH PLATING ON CONTACT AREA;								
F	BREAK TERMINAL	1	PHOSPHOR BRONZE 0.2t	Sn 120u" ON SOLDER TAIL AREA; ALL OVER 50u" NICKET PLATING.								
E	SHUNT TERMINAL-A	1	BRASS 0.25t									
D	RING SPRING	1	PHOSPHOR BRONZE 0.2t									
C	TIP SPRING	1	PHOSPHOR BRONZE 0.25t									
B	EARTH-A	1	COPPER ALLOY 0.2t	Ag 20u" MIN.								
A	BODY	1	PA10T UL 94V-0	BLACK								
NO	DESCRIPTION	QTY	MATERIAL	PLATING & COLOR								
UNLESS OTHERWISE SPECIFIED TOLERANCES			Singatron Enterprise Co., Ltd. 信音企業股份有限公司									
DECIMALS:		ANGLES:		TITLE								
X	:±0.5	X	:±2°	Ø3.50 AUDIO JACK PART NO. 2SJ3015-011111F								
X.X	:±0.3	X.X	:±1°									
X.XX	:±0.2											
<table border="1"> <tr> <td>DWN</td> <td>YULIN</td> <td>SCALE:4:1</td> <td>UNIT: mm</td> <td rowspan="2"> </td> </tr> <tr> <td>CHKD</td> <td>CERRY</td> <td>SIZE: A3</td> <td>SHEET: 1 OF 1</td> </tr> </table>					DWN	YULIN	SCALE:4:1	UNIT: mm		CHKD	CERRY	SIZE: A3
DWN	YULIN	SCALE:4:1	UNIT: mm									
CHKD	CERRY	SIZE: A3	SHEET: 1 OF 1									
CUSTOMER COPY REV: C												

RECOMMENDED PCB LAYOUT(TOP VIEW)
(TOLERANCE: ±0.05)

RECOMMENDED PLUG
4-POLE(TOLERANCE: ±0.05)

3D VIEW