

REV.	ECN NO OR DESCRIPTION	REVISED	DATE
A	PDR RELEASE	IVY-C	2016.01.28

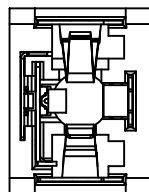

SPECIFICATIONS:

- ELECTRICAL CHARACTERISTICS:**
 - CURRENT RATING: 0.5 AMP.
 - VOLTAGE RATING: 30V.
 - CONTACT RESISTANCE: 30mΩ MAX.
 - INSULATION RESISTANCE: 100MΩ MIN. @ 500V DC.
 - DIELECTRIC WITHSTANDING VOLTAGE: 500V AC FOR 1 MINUTE.
- MECHANICAL CHARACTERISTICS:**
 - INSERTION FORCE: 0.4~3.0 Kgf.
 - WITHDRAWAL FORCE: 0.4~3.0 Kgf.
- LIFE TEST: 5,000 CYCLES.**
- OTHER GENERAL SPEC. TO REFER "2.5φ 3.5φ PHONE JACK SPEC".**
- TO CONFORM TO THE SINGATRON HAZARDOUS SUBSTANCE FREE SPEC.**
- HALOGEN FREE PRODUCT IDENTIFICATION LABEL ON PACKAGING:**
- PACKAGE: SEE "2SJ3017-001331F" PACKAGE.**
- FOR REFLOW SOLDERING LEAD-FREE PROCESS.**

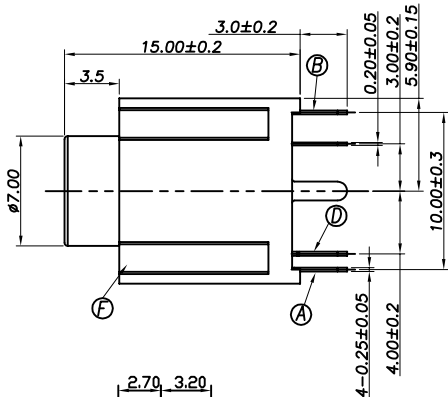
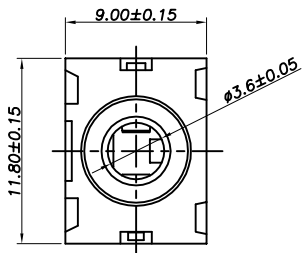
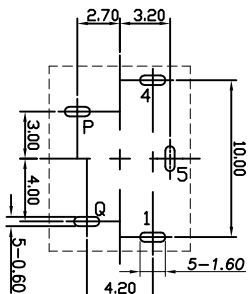
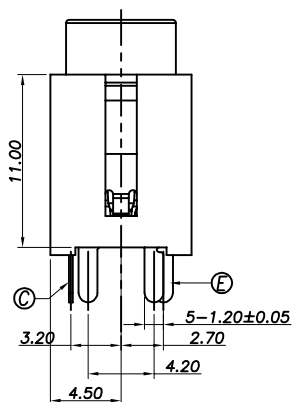

RECOMMENDED P.C.B LAYOUT
TOLERANCE: ±0.1MM (BOTTOM VIEW)

PART NO.

2SJ3017-001331F

- SUFFIX: HALOGEN FREE
- PACKAGE: 1: TAPE & REEL, CARRIER WIDTH=32mm
- HOUSING COLOR: 3: LIME(577C)
- CONTACT PLATING: 3: GOLD FLASH OVERALL

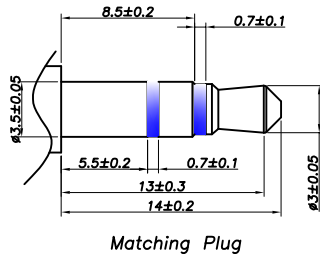
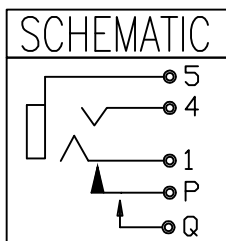
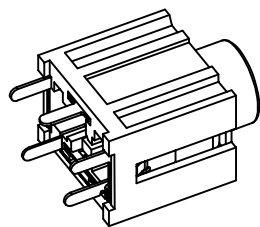
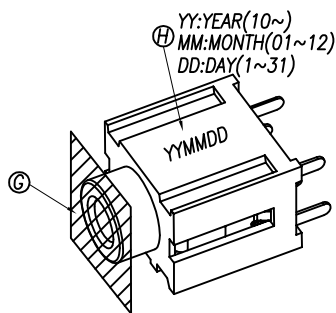

H	INK		BLACK	
G	MYLAR		KAPTON	
F	HOUSING	1	HIGH TEMP. THERMOPLASTIC UL 94V-0 LIME(577C)	
E	CONTACT #P	1	PHOSPHOR BRONZE GOLD FLASH OVERALL	
D	CONTACT #Q	1	PHOSPHOR BRONZE GOLD FLASH OVERALL	
C	CONTACT #5	1	PHOSPHOR BRONZE GOLD FLASH OVERALL	
B	CONTACT #4	1	PHOSPHOR BRONZE GOLD FLASH OVERALL	
A	CONTACT #1	1	PHOSPHOR BRONZE GOLD FLASH OVERALL	
NO	DESCRIPTION	QTY	MATERIAL	PLATING & COLOR
UNLESS OTHERWISE SPECIFIED TOLERANCES		Singatron Enterprise Co., Ltd. 信音企業股份有限公司		
DECIMALS:	ANGLES:	TITLE	φ3.5MM AUDIO JACK, VERTICAL TYPE	
X : ±0.5	X : ±2°	DWN	IV-C 2016.01.28	PART NO. 2SJ3017-001331F
X.X : ±0.3	X.X : ±1°	CHKD	ANCEA 2016.01.28	SCALE 1:1 UNIT: mm
X.XX : ±0.2		APVD	ANCEA 2016.01.28	SIZE: A3 SHEET: 1 OF 1 REV: A
CUSTOMER COPY				