

| REV. | ECN NO OR DESCRIPTION | REVISED | DATE       |
|------|-----------------------|---------|------------|
| A    | PDR NO:T170317-2A     | Steven  | 2018.01.16 |

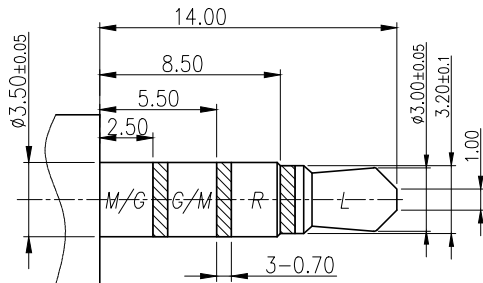

RECOMMENDED PLUG;TOL.±0.05  
Ø3.5 4-POLE STANDARD PLUG

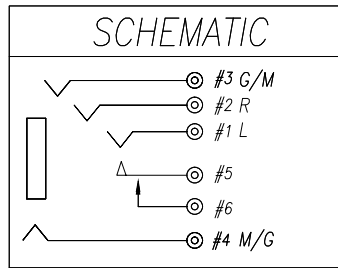
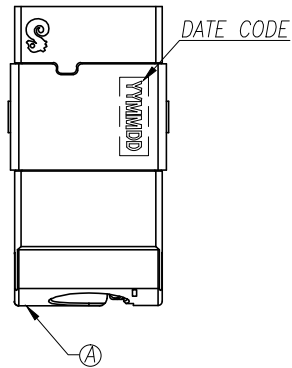

SPECIFICATIONS:

1. ELECTRICAL CHARACTERISTICS:
  - 1-1. RATING: 12V 1A
  - 1-2. CONTACT RESISTANCE: 50mΩ MAX.(INITIAL)
  - 1-3. DIELECTRIC WITHSTANDING VOLTAGE: 500V AC FOR ONE MINUTE.
  - 1-4. INSULATION RESISTANCE: 100MΩ MIN. MEASURED BY 500 VDC.
2. MECHANICAL CHARACTERISTICS:
  - 2-1. INSERTION FORCE: INITIAL 0.3-3.0Kgf;
  - 2-2. WITHDRAWAL FORCE: INITIAL 0.27-2.2Kgf;
3. LIFE TEST: 5,000 CYCLES MIN.  
AFTER LIFE TEST, CONTACT RESISTANCE: 100mΩ MAX.
4. PACKAGING : TAPE & REEL.
5. AFTER HUMIDITY TEST, INSULATION RESISTANCE: 50MΩ MIN.
6. TO CONFORM TO SINGATRON HAZARDOUS SUBSTANCE FREE SPEC.
7. HALOGEN FREE PRODUCT IDENTIFICATION MARK ON PRODUCT: (Symbol)
8. HALOGEN FREE PRODUCT IDENTIFICATION LOGO ON PACKAGING: (Symbol)
9. FOR REFLOW SOLDERING LEAD-FREE PROCESS.
10. PRINTED DATE CODE "YYMMDD-" ON TOP OF CONNECTOR.

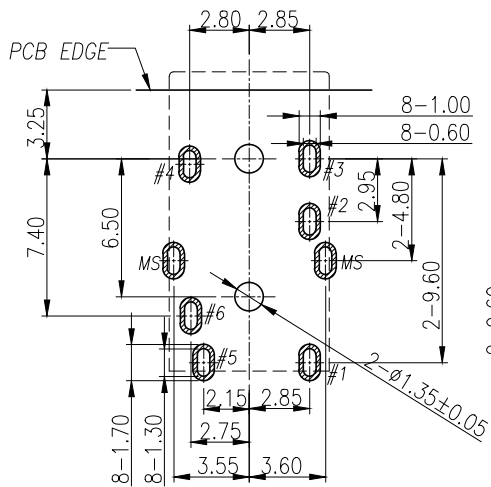
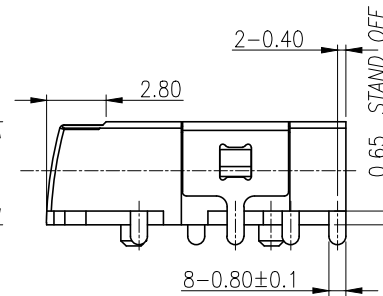
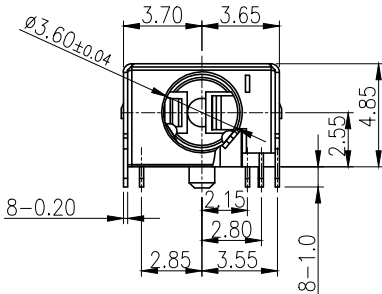
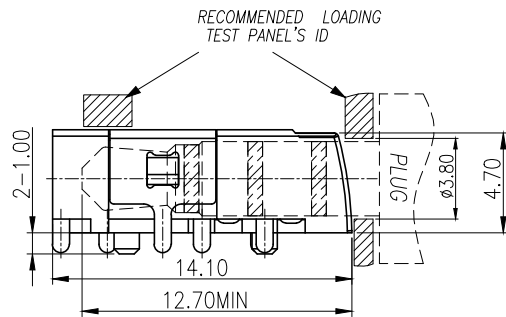

RECOMMENDED PCB LAYOUT  
TOP VIEW ; TOL.±0.05

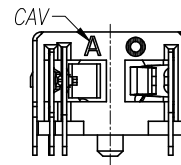
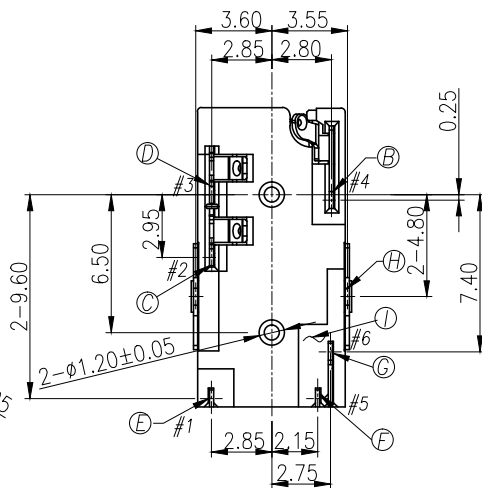

| I  | SEPARATOR         | 1   | E130i+30%GF<br>UL 94V-0     | BLACK                                                                                          |
|----|-------------------|-----|-----------------------------|------------------------------------------------------------------------------------------------|
| H  | SHELL             | 1   | C5210-H 0.2t                | Ni 60u" MIN                                                                                    |
| G  | MAKE TERMINAL     | 1   | C5210-EH 0.2t               | GOLD FLASH ON CONTACT AREA;<br>GOLD FLASH ON SOLDER AREA;<br>ALL OVER NICKEL 50u" MIN. PLATING |
| F  | TRANSFER TERMINAL | 1   | C5210-EH 0.2t               |                                                                                                |
| E  | TIP SPRING        | 1   | C5210-EH 0.2t               |                                                                                                |
| D  | RING-B            | 1   | C5210-EH 0.2t               |                                                                                                |
| C  | RING-A            | 1   | C5210-EH 0.2t               |                                                                                                |
| B  | EARTH             | 1   | C5210-EH 0.2t               |                                                                                                |
| A  | BODY              | 1   | PA4T+30%GF, TX1<br>UL 94V-0 | BLACK                                                                                          |
| NO | DESCRIPTION       | QTY | MATERIAL                    | PLATING & COLOR                                                                                |

UNLESS OTHERWISE SPECIFIED TOLERANCES

Singatron Enterprise Co., Ltd.  
信音企業股份有限公司

|                                              |                            |                                                |                                                                                           |        |
|----------------------------------------------|----------------------------|------------------------------------------------|-------------------------------------------------------------------------------------------|--------|
| DECIMALS: X :±0.5<br>X.X :±0.3<br>X.XX :±0.2 | ANGLES: X :±2°<br>X.X :±1° | TITLE<br>DWN Steven<br>CHKD Bruce<br>APVD Liao | 3.5ø PHONE JACK<br>PART NO.2SJ3072-252111F<br>SCALE 1:1 UNIT: mm<br>SIZE: A3 SHEET:1 OF 1 | REV: A |
|----------------------------------------------|----------------------------|------------------------------------------------|-------------------------------------------------------------------------------------------|--------|

**CUSTOMER COPY**