

REV.	ECN NO OR DESCRIPTION	REVISED	DATE
A	PDR NO: T170112-3A	ROBIN	2017.09.03

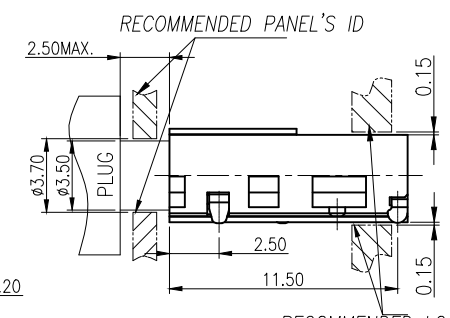
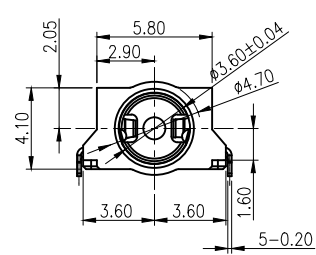
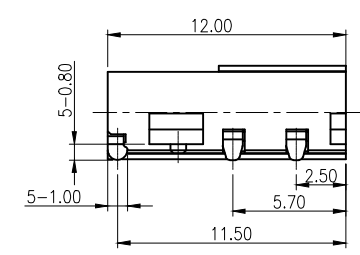

RECOMMENDED LOADING TEST PANEL'S ID

SPECIFICATIONS:

- ELECTRICAL CHARACTERISTICS:
 - RATING: 12V 1A
 - CONTACT RESISTANCE: 50mΩ MAX.(INITIAL)
 - DIELECTRIC WITHSTANDING VOLTAGE: 500V AC FOR ONE MINUTE.
 - INSULATION RESISTANCE: 100MΩ MIN. MEASURED BY 500 VDC.
- MECHANICAL CHARACTERISTICS:
 - INSERTION FORCE: INITIAL 0.3-3.0Kgf;
 - WITHDRAWAL FORCE: INITIAL 0.3-3.0Kgf;
- LIFE TEST: 5000 CYCLES MIN.
AFTER LIFE TEST, CONTACT RESISTANCE: 120mΩ MAX.
- PACKAGING : TAPE & REEL.
- AFTER HUMIDITY TEST, INSULATION RESISTANCE: 50MΩ MIN.
- TO CONFORM TO SINGATRON HAZARDOUS SUBSTANCE FREE SPEC.
- HALOGEN FREE PRODUCT IDENTIFICATION MARK ON PRODUCT:
- HALOGEN FREE PRODUCT IDENTIFICATION LOGO ON PACKAGING:
- FOR LEAD-FREE PROCESS.
- PRINTED DATE CODE "YYMMDD-" ON TOP OF CONNECTOR.

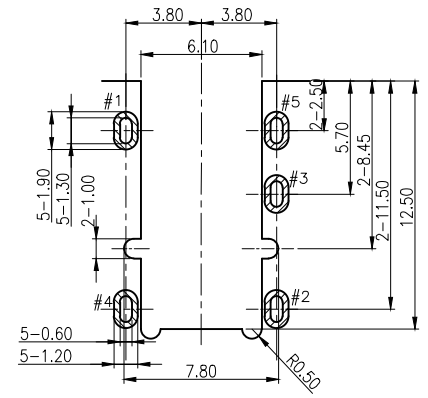

RECOMMEND PCB LAYOUT TOP VIEW(TOL.±0.05)

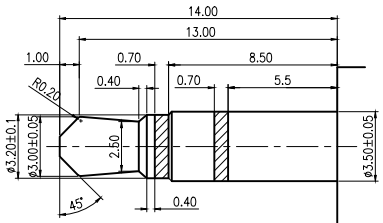
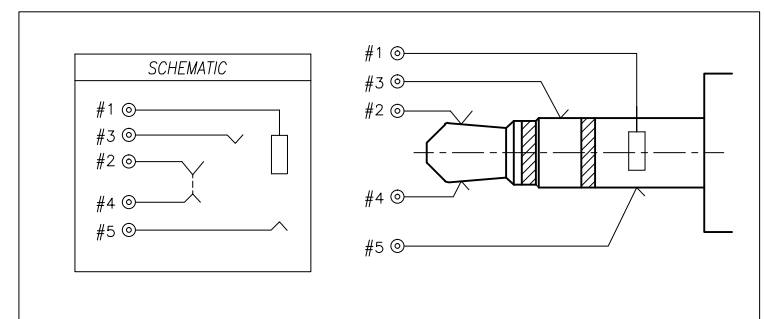
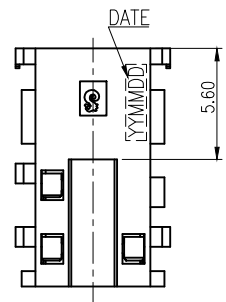
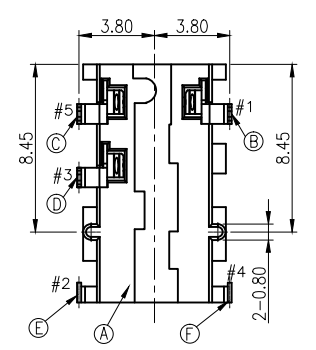

RECOMMENDED PLUG(TOL.±0.05)
ø3.5 3-POLE STANDARD PLUG

F	TIP-B	1	COPPER ALLOY 0.2t	GOLD FLASH ON CONTACT, GOLD FLASH ON SOLDER TAIL ALL OVER Ni 50u" Min.			
E	TIP-A	1	COPPER ALLOY 0.2t				
D	RING	1	PHOSPHOR BRONZE 0.2t				
C	EARTH-B	1	PHOSPHOR BRONZE 0.2t	BLACK			
B	EARTH-A	1	PHOSPHOR BRONZE 0.2t				
A	BODY	1	HIGH TEMP.THERMOPLASTIC UL 94V-0				
NO	DESCRIPTION	QTY	MATERIAL	PLATING & COLOR			
UNLESS OTHERWISE SPECIFIED TOLERANCES			Singatron Enterprise Co., Ltd. 信音企業股份有限公司				
DECIMALS:		TITLE					
ANGLES:		3.5ø PHONE JACK					
X	:±0.5	X	:±2°	DWN	ROBIN	PART NO.2SJ3081-003111F	
X.X	:±0.3	X.X	:±1°	CHKD	BRUCE	SCALE:4:1	UNIT: mm
X.XX	:±0.2	APVD	LUSSEN	SIZE: A3	SHEET:1 OF 1	REV:A	
CUSTOMER COPY							